



# Hitachi Compute Blade CB2000 / CB320 LAN Adapter User's Manual

## FASTFIND LINKS

[Getting Help](#)

[Contents](#)

© 2010-2014 Hitachi, Ltd. All rights reserved.

No part of this publication may be reproduced or transmitted in any form or by any means, electronic or mechanical, including photocopying and recording, or stored in a database or retrieval system for any purpose without the express written permission of Hitachi, Ltd.

Hitachi, Ltd., reserves the right to make changes to this document at any time without notice and assumes no responsibility for its use. This document contains the most current information available at the time of publication. When new or revised information becomes available, this entire document will be updated and distributed to all registered users.

Some of the features described in this document might not be currently available. Refer to the most recent product announcement for information about feature and product availability, or contact Hitachi Data Systems Corporation at <https://portal.hds.com>.

**Notice:** Hitachi, Ltd., products and services can be ordered only under the terms and conditions of the applicable Hitachi Data Systems Corporation agreements. The use of Hitachi, Ltd., products is governed by the terms of your agreements with Hitachi Data Systems Corporation.

Hitachi is a registered trademark of Hitachi, Ltd., in the United States and other countries. Hitachi Data Systems is a registered trademark and service mark of Hitachi, Ltd., in the United States and other countries.

Archivas, Essential NAS Platform, HiCommand, Hi-Track, ShadowImage, Tagmaserve, Tagmasoft, Tagmasolve, Tagmastore, TrueCopy, Universal Star Network, and Universal Storage Platform are registered trademarks of Hitachi Data Systems Corporation.

AIX, AS/400, DB2, Domino, DS6000, DS8000, Enterprise Storage Server, ESCON, FICON, FlashCopy, IBM, Lotus, MVS, OS/390, RS6000, S/390, System z9, System z10, Tivoli, VM/ESA, z/OS, z9, z10, zSeries, z/VM, and z/VSE are registered trademarks or trademarks of International Business Machines Corporation.

All other trademarks, service marks, and company names in this document or website are properties of their respective owners.

Microsoft product screen shots are reprinted with permission from Microsoft Corporation.



# Contents

Preface .....	v
Intended Audience .....	vi
Release Notes .....	vi
Referenced Documents .....	vi
Document Conventions .....	vii
Convention for storage capacity values .....	viii
Getting Help .....	viii
Comments .....	viii
Outline .....	1-1
Installation on System Equipment .....	2-1
Driver .....	3-1
Utility .....	4-1
LAN Advanced Functions .....	5-1
Specification .....	6-1





# Preface

This document describes how to use the Hitachi Compute Blade CB2000 / CB320 LAN adapter such as installation, connection, and handling.

This preface includes the following information:

- [Intended Audience](#)
- [Release Notes](#)
- [Referenced Documents](#)
- [Document Conventions](#)
- [Convention for storage capacity values](#)
- [Getting Help](#)
- [Comments](#)

**Notice:** The use of Hitachi Compute Blade CB2000 / CB320 LAN adapter User's Manual and all other Hitachi Data Systems products is governed by the terms of your agreement with Hitachi Data Systems.

## Intended Audience

This document is intended for personnel involved in planning, managing, and performing the tasks to prepare your site for Compute Blade installation. This document assumes the following:

- . The reader has a background in hardware installation of computer systems.
- . The reader is familiar with the location where the Compute Blade will be installed, including

knowledge of physical characteristics, power systems and specifications, and environmental specifications.

## Release Notes

Read the release notes before installing and using this product. They may contain requirements or restrictions that are not fully described in this document or updates or corrections to this document.

## Referenced Documents

Hitachi Compute Blade documents:





- Hitachi Compute Blade 2000 SOFTWARE GUIDE
- Hitachi Compute Blade 320 SOFTWARE GUIDE

# Document Conventions

This document uses the following typographic conventions:

Convention	Description
<b>Regular text bold</b>	In text: keyboard key, parameter name, property name, hardware labels, hardware button, hardware switch. In a procedure: user interface item
<i>Italic</i>	Variable, emphasis, reference to document title, called-out term
Screen text	Command name and option, drive name, file name, folder name, directory name, code, file content, system and application output, user input
< > (angled brackets)	Variable (used when italic is not enough to identify variable).
[ ] (square bracket)	Optional values
{ } braces	Required or expected value
vertical bar	Choice between two or more options or arguments
_(underline)	Default value, for example, [ <u>a</u> ] b

This document uses the following icons to draw attention to information:

Icon	Meaning	Description
	WARNING	This indicates the presence of a potential risk that might cause death or severe injury.
	CAUTION	This indicates the presence of a potential risk that might cause relatively mild or moderate injury.
<b>NOTICE</b>	NOTICE	This indicates the presence of a potential risk that might cause severe damage to the equipment and/or damage to surrounding properties.
	Note	This indicates notes not directly related to injury or severe damage to equipment.
	Tip	This indicates advice on how to make the best use of the equipment.

## Convention for storage capacity values

Physical storage capacity values (for example, disk drive capacity) are calculated based on the following values:

Physical capacity unit	Value
1 kilobyte (KB)	1,000 ( $10^3$ ) bytes
1 megabyte (MB)	1,000 KB or $1,000^2$ bytes
1 gigabyte (GB)	1,000 MB or $1,000^3$ bytes
1 terabyte (TB)	1,000 GB or $1,000^4$ bytes
1 petabyte (PB)	1,000 TB or $1,000^5$ bytes
1 exabyte (EB)	1,000 PB or $1,000^6$ bytes

Logical storage capacity values (for example, logical device capacity) are calculated based on the following values:

Logical capacity unit	Value
1 block	512 bytes
1 KB	1,024 ( $2^{10}$ ) bytes
1 MB	1,024 KB or $1,024^2$ bytes
1 GB	1,024 MB or $1,024^3$ bytes
1 TB	1,024 GB or $1,024^4$ bytes
1 PB	1,024 TB or $1,024^5$ bytes
1 EB	1,024 PB or $1,024^6$ bytes

## Getting Help

The Hitachi Data Systems customer support staff is available 24 hours a day, seven days a week. If you need technical support, log on to the Hitachi Data Systems Portal for contact information: <https://portal.hds.com>

## Comments

Please send us your comments on this document: [doc.comments@hds.com](mailto:doc.comments@hds.com). Include the document title and number including the revision level (for example, -07), and refer to specific sections and paragraphs whenever possible. All comments become the property of Hitachi Data Systems Corporation.

**Thank you!**



# Outline

This chapter contains an outline of the LAN adapter.

- [Feature](#)
- [Supported OS](#)
- [Note](#)
- [Restriction](#)

## Features

These Compute Blade CB2000 / CB320 LAN adapters are installed in PCI Express (henceforth PCIe) slot of the system device. These products have the following features.

These adapters correspond to 1000BASE-T (IEEE802.3ab)

These adapters have the network interface connector by two ports or four ports

These adapters are connected with Cat.5e cable

These adapters can be installed in PCI Express x4 Slot or x8 Slot

## Supported OS's

These Compute Blade CB2000 / CB320 LAN adapters can be used with the following OS's

Windows Server 2003 R2 SP2

Windows Server 2008

Windows Server 2008 R2

Windows Server 2012

Windows Server 2012 R2 (Not supported for CB320)

Red Hat Enterprise Linux 5.3 or later

Red Hat Enterprise Linux 6.1 or later

VMware ESX 4.0 update 1 or later

VMware ESX 4.1

VMware ESXi 5.0

VMware ESXi 5.1

VMware ESXi 5.5

## Notes

Notes on Networking on Windows Server 2003 R2 SP2

It is confirmed that communication using the TCP layer protocol may fail after installing Windows Server 2003 R2 SP2.

The details are released on the following Microsoft website:

KB936594 (<http://support.microsoft.com/kb/936594/en>)

See "Compute Blade 2000 SOFTWARE GUIDE" of the System Equipment attachment for details.

## Restrictions

About PXE boot

The PXE boot is not supported in this adapter.

About Wake on LAN

The Wake on LAN is not supported in this adapter.

About iSCSI boot

The iSCSI boot is not supported in this adapter.

About TCP/IP Checksum Offload function of the network adapter

This LAN adapter has the TCP/IP protocol checksum calculation function that is executed on LAN controller.

It is recommended, however, to use the TCP/IP checksum calculation function that OS provides as standard, rather than to use this function. You can construct more high reliability system if the calculation function of OS side is set available.

That is because the correspondence confirmation of the packet data received from the network will be performed in the last phase of the OS protocol processing. Follow the description below to turn off the checksum function by LAN controller.

Please refer to "LAN controller function supplementation matter" of the System Equipment attachment for setup steps on each OS.



# Installation on System Equipment

This chapter explains the installation of Compute Blade CB2000 / CB320 LAN adapters into the system equipment.

- [Installing LAN Adapter](#)
- [Outside Appearance \(2-port 1000Base-T LAN Adapter\)](#)
- [LED Specification \(2-port 1000Base-T LAN Adapter\)](#)
- [Outside Appearance \(4-port 1000Base-T LAN adapter\)\(4-port 1000Base-T LAN adapter \(ET2\)\)](#)
- [LED Specification \(4-port 1000Base-T LAN adapter\)\(4-port 1000Base-T LAN adapter \(ET2\)\)](#)
- [Installation of Cable](#)

## Installing LAN Adapter

 WARNING

Addition or replacement of optional components must be performed by maintenance personnel. Do not attempt to remove the cover of the equipment. Do not attempt to install or remove optional components. Parts implemented in the system equipment are high-density, and highly complex. Operation or maintenance by inexperienced persons may lead to injury or equipment failure. When you need to add or replace optional components, contact your dealer or call maintenance personnel.

Only maintenance personnel are allowed to add each optional component to the system. Contact the reseller from which you have purchased the equipment or call maintenance personnel.



When the 1000Base-T LAN adapter is additionally installed after Windows Server 2012 R2 is installed, execute the following file.

e1iemsg.bat

This file is included in the media "Server installation and monitoring tool ver.03-\*\* (or later)". See the "Support\_EN.html" in the media and click "Utilities (WS12R2/WS12/WS08R2/WS08)" of each system equipment, and see the path to "e1iemsg.bat" in "Registry update" column.

## Outside Appearance (2-port 1000Base-T LAN Adapter)

- Top view

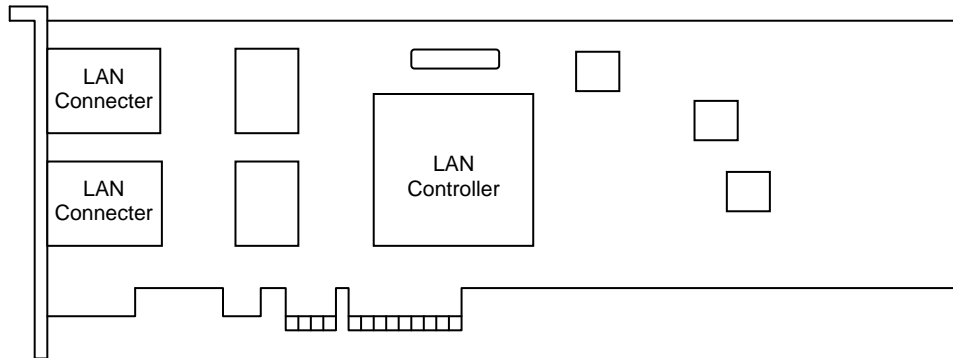

- Side view

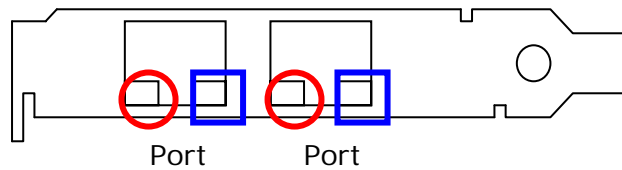

○ : ACT/LNK, □ : 10/100/1000

## LED Specification (2-port 1000Base-T LAN Adapter)

LED Mark	Color	Condition	State
ACT/LNK	---	Turn off	Power off/Link down
	Green	Blinking	Data transfer
	Green	Lighting	Link up
10/100/1000	---	Turn off	Power off/10Mbps Link up
	Green	Lighting	100Mbps Link up
	Amber	Lighting	1000Mbps Link up

## Outside Appearance (4-port 1000Base-T LAN adapter)(4-port 1000Base-T LAN adapter (ET2))

- Top view

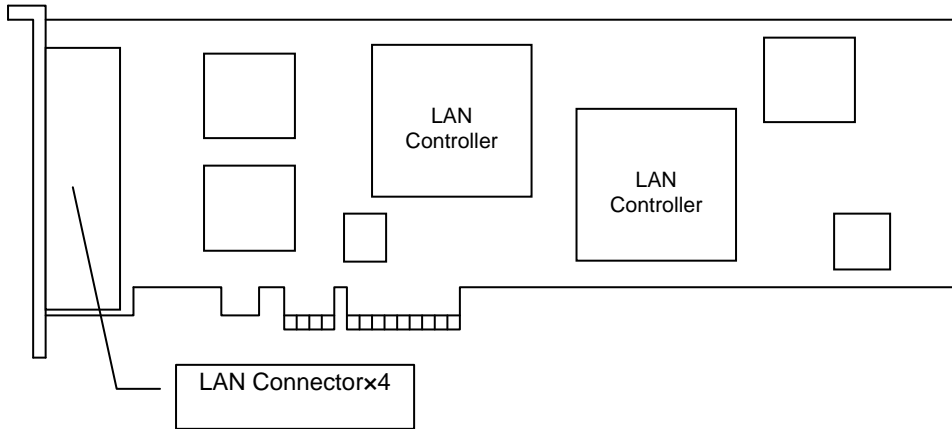

- Side view

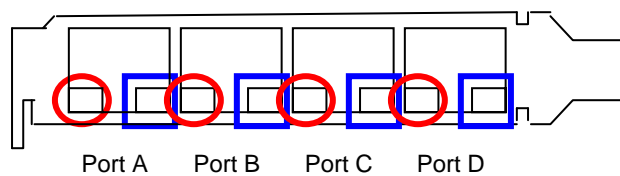

○ : ACT/LNK, □ : 10/100/1000

## LED Specification (4-port 1000Base-T LAN adapter)(4-port 1000Base-T LAN adapter (ET2))

LED Mark	Color	Condition	State
ACT/LNK	---	Turn off	Power off/Link down
	Green	Blinking	Data transfer
	Green	Lighting	Link up
10/100/1000	---	Turn off	Power off/10Mbps Link up
	Green	Lighting	100Mbps Link up
	Amber	Lighting	1000Mbps Link up



## Intallation of Cable

 CAUTION

**Signal cables**

When wiring cables, take care not to trip over the cables. It could cause injury or failure of devices connected to the equipment. It could also cause loss of valuable data.

NOTICE

**Signal cables**

Do not place heavy items on the cables. Avoid wiring cables close to a thermal appliance. It may cause damage to cable sheaths, resulting in failure of the connected devices.

Refer to "P.52-54 Basic Specification" for LAN cable connected with this LAN adapter.

Please don't use cables other than LAN cable.

1. Insert LAN cable to Compute Blade 2000/ Compute Blade 320 LAN Adapter until being locked.
2. Insert LAN cable to connection destination such as LAN switches until being locked.



## Driver

This chapter explains the setup of driver of the Compute Blade CB2000 / CB320 LAN adapters.

- [To get the drivers](#)
- [How to install driver \(Windows Server 2012/Windows Server 2012 R2\)](#)
- [How to confirm the driver version \(Windows Server 2012/Windows Server 2012 R2\)](#)
- [How to install driver \(Windows Server 2008/Windows Server 2008 R2\)](#)
- [How to confirm the driver version \(Windows Server 2008/Windows Server 2008 R2\)](#)
- [How to install driver \(Windows Server 2003 R2\)](#)
- [How to confirm the driver version \(Windows Server 2003 R2\)](#)
- [How to install driver \(Red Hat Enterprise Linux\)](#)
- [How to confirm the driver version \(Red Hat Enterprise Linux\)](#)

## To get the drivers

The LAN drivers for Compute Blade 320 LAN adapter are in " Hitachi Compute Blade Driver Kit (Version 05-04 or later)" CD-ROM or "Hitachi Server Navigator" media attached to the system equipment.

The LAN drivers for the Compute Blade 2000 LAN adapter are in " Hitachi Compute Blade 2000 Driver Kit CD (12-10 or later)" or "Hitachi Server Navigator" media or "Server installation and monitoring tool" attached to the system equipment.

The LAN drivers for Windows 2012 are in "Driver Kit for Windows Server 2012" media or "Hitachi Server Navigator" media or "Server installation and monitoring tool ver.03-\*\* (or later)" media attached to the system equipment.

The LAN driver for Windows 2012 R2 is included in Windows Server 2012 R2 (inbox driver).

The LAN driver for VMware can be downloaded from the Web site.

<http://www.vmware.com/>

Download the driver for Intel 82576 Gigabit Ethernet Controllers.

# How to install driver(Windows Server 2012/Windows Server 2012 R2)



The installation of the driver for the adapter on Windows Server 2012 R2 is not necessary. Use the inbox driver that is contained in Windows Server 2012 R2.

When the 1000Base-T LAN adapter is additionally installed after Windows Server 2012 R2 is installed, execute the following file.

e1iemsg.bat

This file is included in the media "Server installation and monitoring tool ver.03-\*\* (or later)". See the "Support\_EN.html" in the media and click "Utilities (WS12R2/WS12/WS08R2/WS08)" of each system equipment, and see the path to "e1iemsg.bat" in "Registry update" column.



The driver for the LAN adapter is usually installed when the system equipment is setup. If the system equipment has been setup without "Hitachi Server Navigator" media or "Server installation and monitoring tool" media for example, the appropriate driver may not be installed. In that case, install the driver following the procedure below.

- 1 Turn on the blade server and boot Windows Server 2012, and then log on to the OS as a user with administrator privilege (such as Administrator).
- 2 Insert "Driver Kit for Windows Server 2012" media or "Hitachi Server Navigator" media or "Server installation and monitoring tool" into the DVD drive.
- 3 Select **Start - Server Manager - tool -Computer Management**

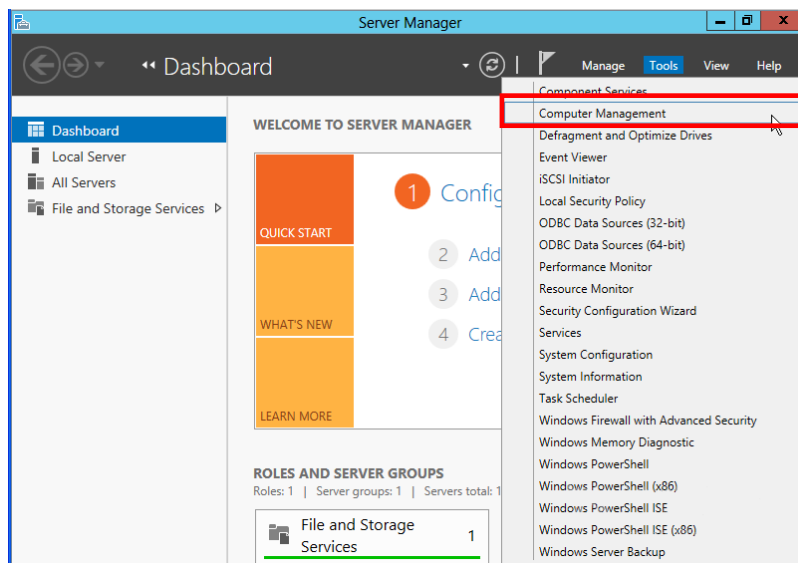

#### 4 Select **Device Manger**.

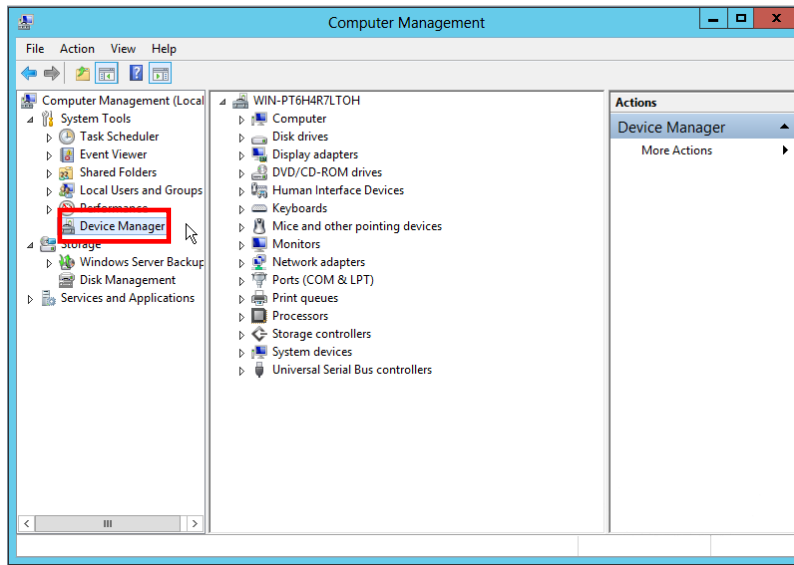

#### 5 Click "Network adapters", and right-click "Intel(R)Gigabit ET\* (\* is letters)", and select "Properties".

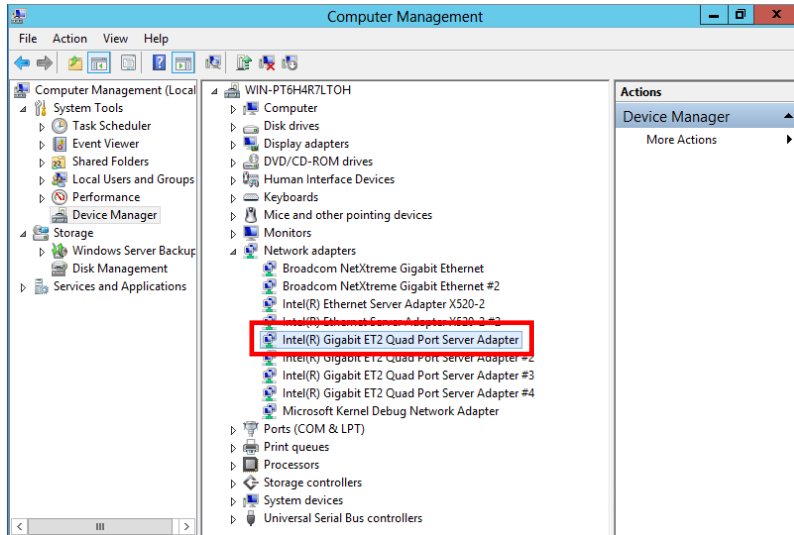

6 The properties window opens. Click "Update Driver..." in "Driver" tab.

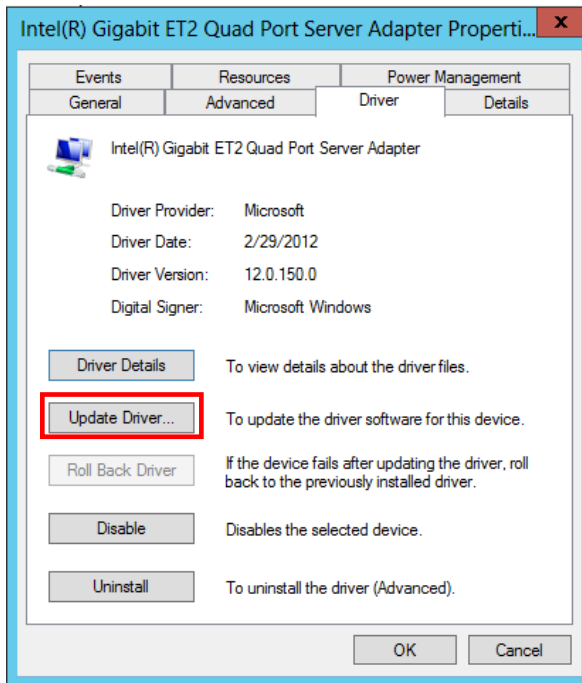

7 Click "Browse my computer for driver software".

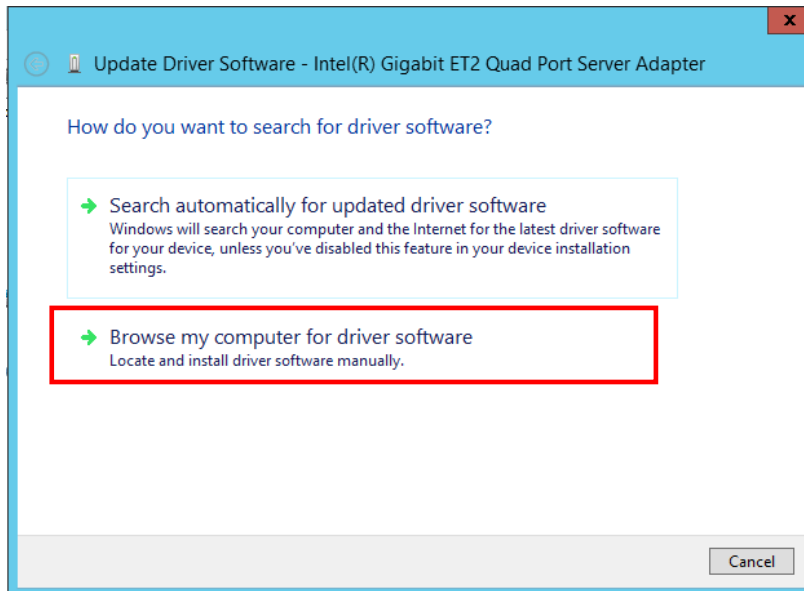

- 8 Select **Search for driver software in this location:** and input the followings. Then click the **Next** button.

Windows Server 2012 :  
"D: \WinSrv2012\Drivers\NIC\IntelNIC\_05\x64

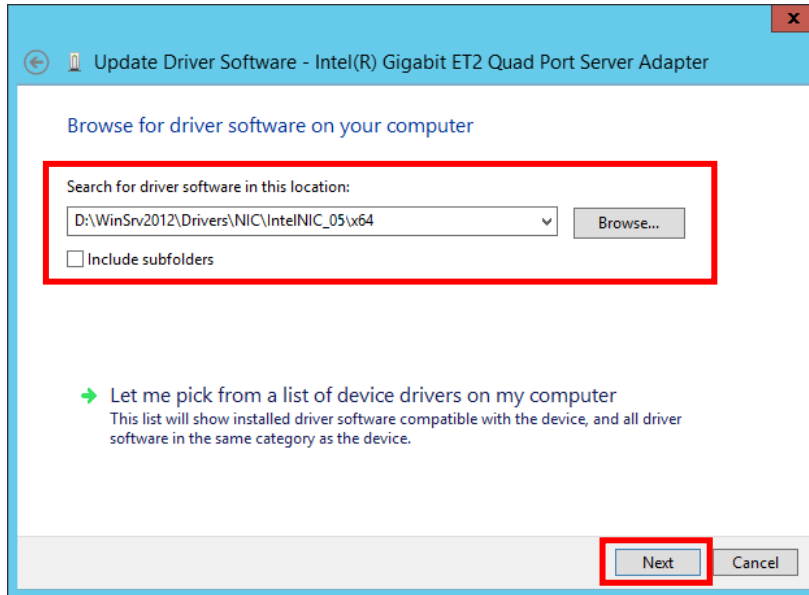

**Tip** D: refers to CD/DVD drive name.

- 9 Confirm that "Windows has successfully updated your driver software." is displayed, and then click the **Close** button.

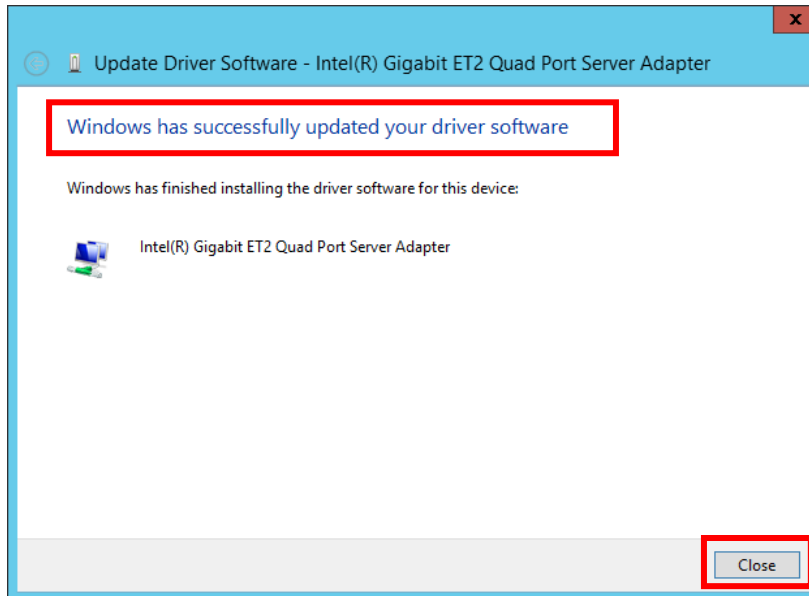

- 10 Repeat the steps 5 through 9 for all "Intel(R)Gigabit ET\* (\* is letters)" .

- 11 Remove the media from the DVD drive, and reboot the system.



# How to confirm the driver version (Windows Server 2012/Windows Server 2012 R2)

- 1 Turn on the blade server, boot Windows Server 2012 / Windows Server 2012 R2, and then log on to the OS as a user with administrator privilege (such as Administrator).
- 2 Open the **Device Manager** window.
- 3 Right-click the **Intel(R)Gigabit ET\*** (\* is letters) under the **Network adapters**, and click **Properties**.

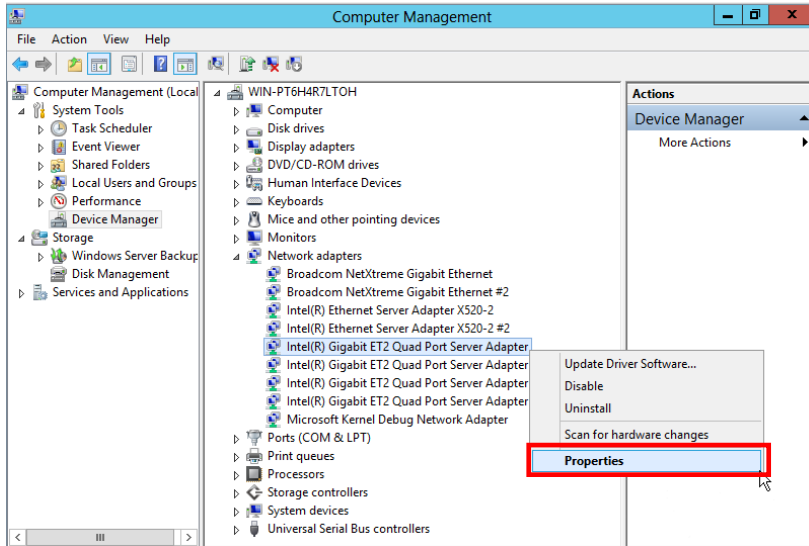

- 4 Click **Driver** tab, and confirm the version displayed on the right of "Driver Version; "

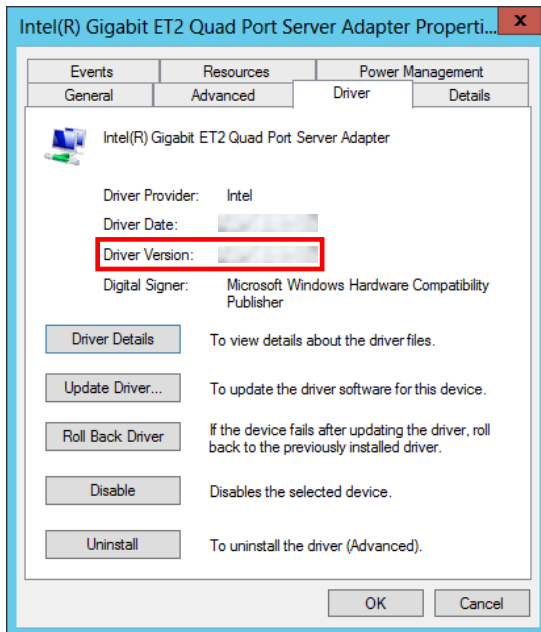

## How to install driver (Windows Server 2008/Windows Server 2008R2)

(The following screens are the Windows Server 2008 32-bit's. The screens for Windows Server 2008 R2 are a little bit different from those of Windows 2008.)



The driver for the LAN adapter is usually installed when the system equipment is setup. If the system equipment has been setup without "Hitachi Compute Blade Driver Kit CD" or "Hitachi Server Navigator" media for example, the appropriate driver may not be installed. In that case, install the driver following the procedure below.

- 1 Turn on the blade server, boot Windows Server 2008, and then log on to the OS as a user with administrator privilege (such as Administrator).
- 2 Insert the driver media into the CD/DVD drive.  
  
CB2000 : "Hitachi Compute Blade 2000 Driver Kit CD (12-10 or later)" or "Hitachi Server Navigator" or "Server installation and monitoring tool".  
  
CB320 : "Hitachi Compute Blade Driver Kit (Version 05-04 or later)" or "Hitachi Server Navigator".
- 3 Click the **Start** button and select **Server Manager**.
- 4 Select **Diagnose** and then **Device Manager**.
- 5 Right-click the network adapter whose driver has not been updated and click **Update Driver Software ....**

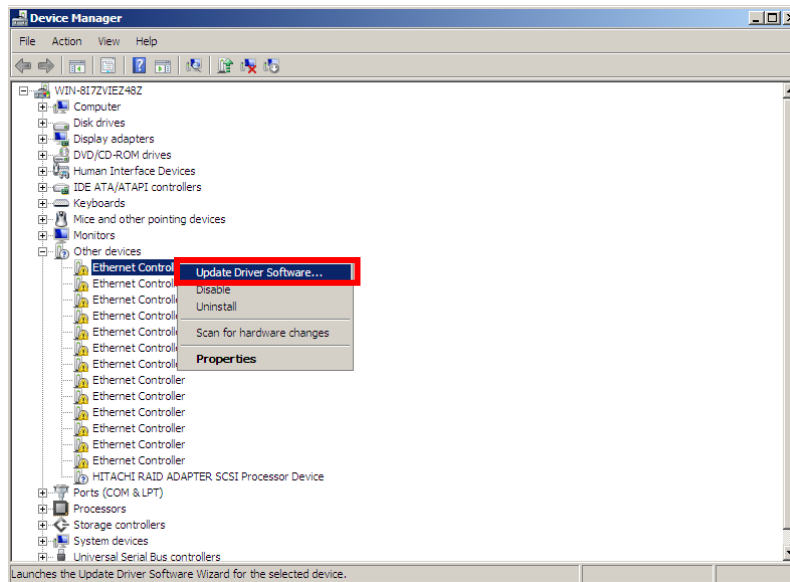

6 Select **Browse my computer for driver software**.

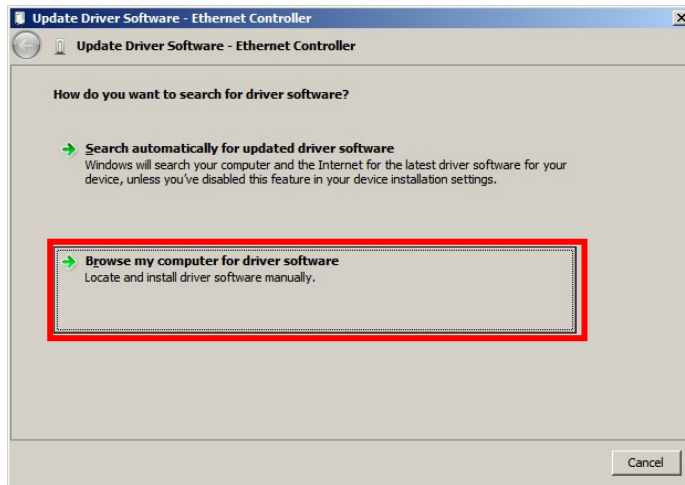

7 Select **Search for driver software in this location:** and input the followings and remove the check mark from **Include subfolders**. Then click the **Next** button.

Compute Blade 2000:

- Using "Driver Kit CD" :

Windows Server 2008 R2 : D:\X55x1\Win2008R2\Drivers\LAN\INTEL\_01\x64

Windows Server 2008 32bit : D:\X55x1\Win2008\Drivers\LAN\INTEL\_01\x86

Windows Server 2008 64bit : D:\X55x1\Win2008\Drivers\LAN\INTEL\_01\x64

- Using "Hitachi Server Navigator" or "Server installation and monitoring tool":

Windows Server 2008 R2 : D:\WinSrv2008R2\Drivers\NIC\IntelNIC\_05\x64

Windows Server 2008 32bit : D:\WinSrv2008\Drivers\NIC\IntelNIC\_05\x86

Windows Server 2008 64bit : D:\WinSrv2008\Drivers\NIC\IntelNIC\_05\x64

Compute Blade 320:

- Using "Driver Kit CD" :

Windows Server 2008 R2 : D:\X51x5\Win2008R2\Drivers\LAN\INTEL\_01\x64

Windows Server 2008 32bit : D:\X51x5\Win2008\Drivers\LAN\INTEL\_01\x86

Windows Server 2008 64bit : D:\X51x5\Win2008\Drivers\LAN\INTEL\_01\x64

- Using "Hitachi Server Navigator" or "Server installation and monitoring tool":

Windows Server 2008 R2 : D:\WinSrv2008R2\Drivers\NIC\IntelNIC\_03\x64

Windows Server 2008 32bit : D:\WinSrv2008\Drivers\NIC\IntelNIC\_03\x86

Windows Server 2008 64bit : D:\WinSrv2008R2\Drivers\NIC\IntelNIC\_03\x64

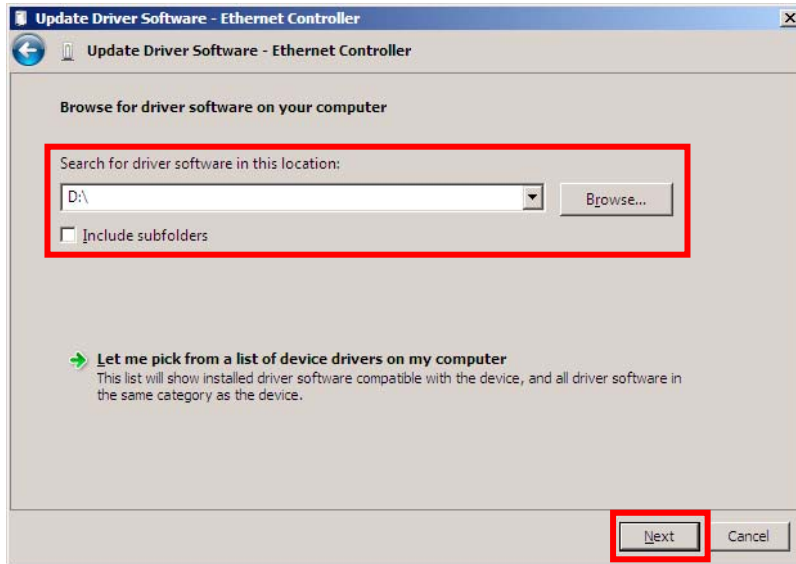

D: refers to CD/DVD drive name.

- 8 Confirm that "Windows has successfully updated your driver software" is displayed, and then click the **Close** button.

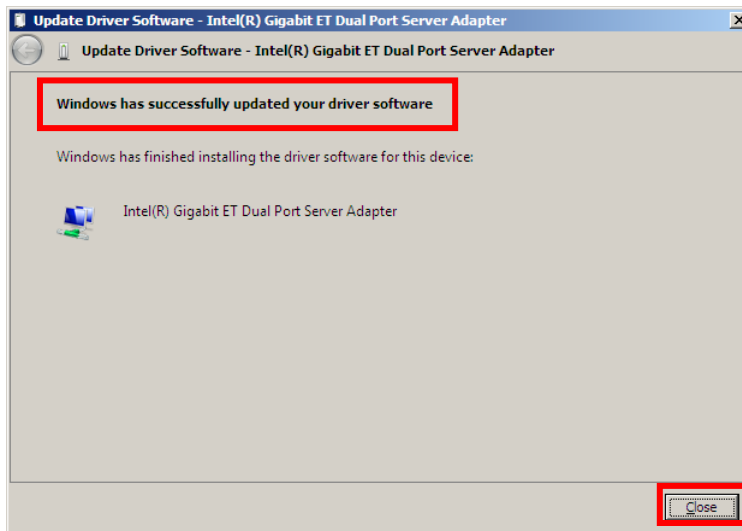



After completing the installation of the driver, **Intel(R) Gigabit ET Dual Port Server Adapter** or **Intel(R) Gigabit ET Quad Port Server Adapter** or **Intel(R) Gigabit ET2 Quad Port Server Adapter** is displayed under the **Network adapters**.

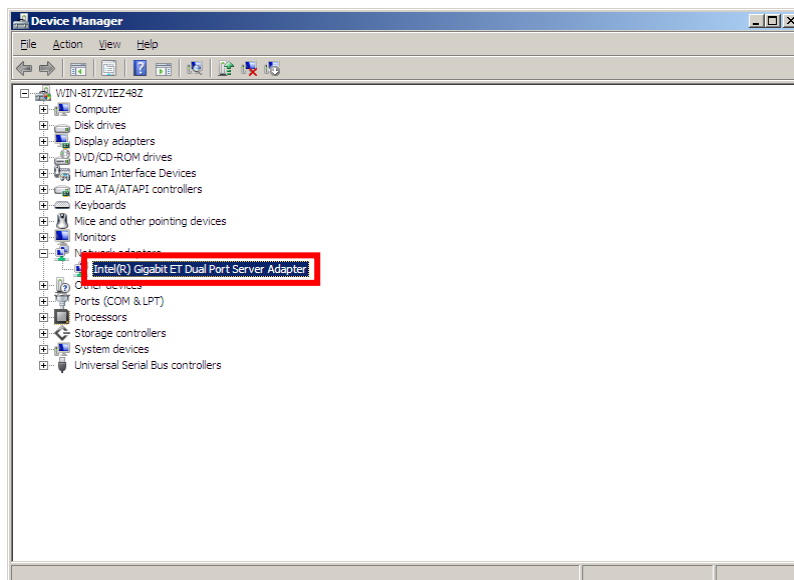

9 If there remain network adapters whose LAN drivers have not been updated, repeat above Steps 5 to 8 for each network adapter.

10 Remove the media from the CD/DVD drive, and reboot the system

## How to confirm the driver version (Windows Server 2008/Windows Server 2008 R2)

- 1 Turn on the blade server, boot Windows Server 2008, and then log on as "Administrator".
- 2 Click the **Start** button and select **Server Manager**.
- 3 Select **Diagnose** and then **Device Manager**.
- 4 Right-click the **Intel(R) Gigabit ET Dual Port Server Adapter** or **Intel(R) Gigabit ET Quad Port Server Adapter** or **Intel(R) Gigabit ET2 Quad Port Server Adapter** under the **Network adapter**, and click **Property**.

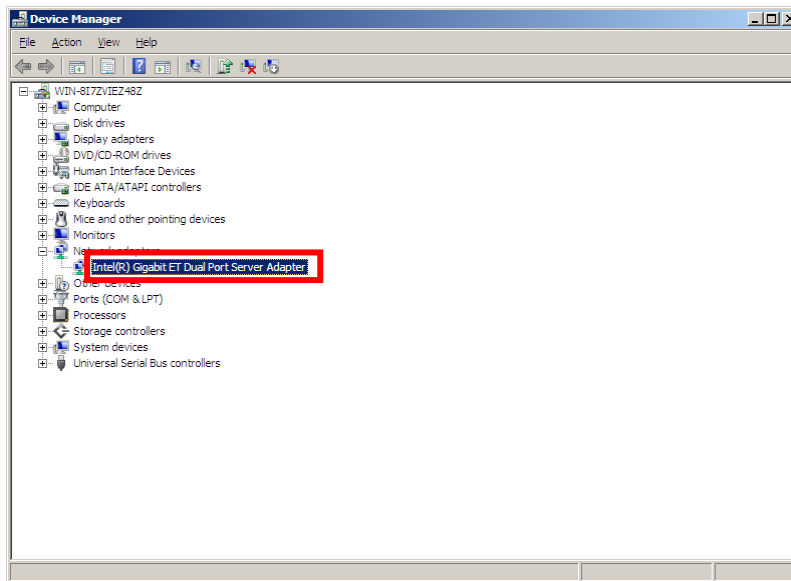

- 5 Click **Driver** tab, and confirm the version displayed on the right of "Driver Version;".

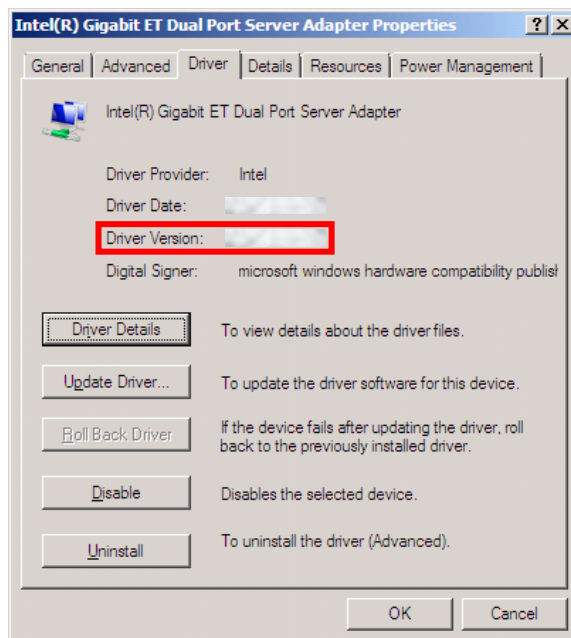

## How to install driver (Windows Server 2003 R2)

- 1 Turn on the blade server, boot Windows Server 2003 R2, and log on as "Administrator".
- 2 Insert "Driver Kit CD for Compute Blade 2000" or "Driver Kit CD for Compute Blade 320" CD-ROM into the CD/DVD drive.
- 3 Click **Start - Control Panel - System**.
- 4 Click **Device Manager** under the **Hardware** tab.

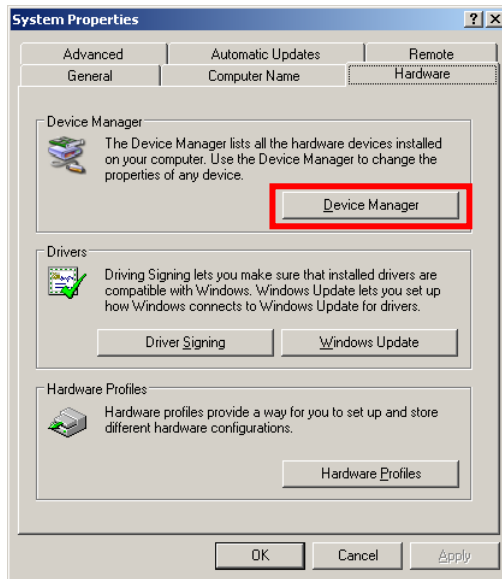

- 5 Double-click **Other Devices** and right-click the network adapter whose driver has not been updated and click **Update Driver ...**

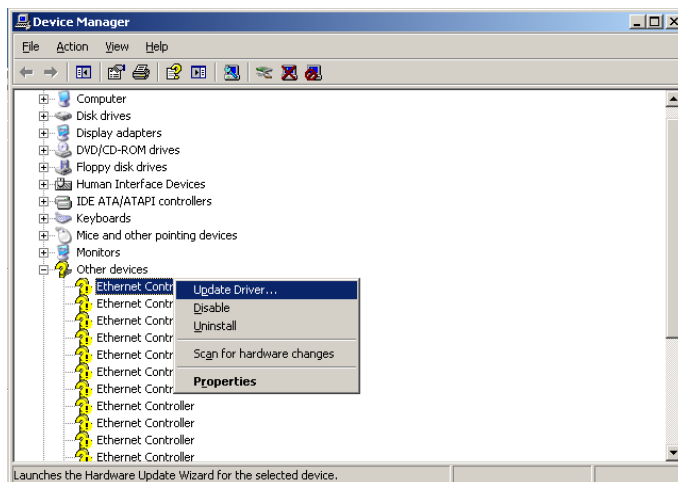

6 Select **No, not this time** and click **Next**.

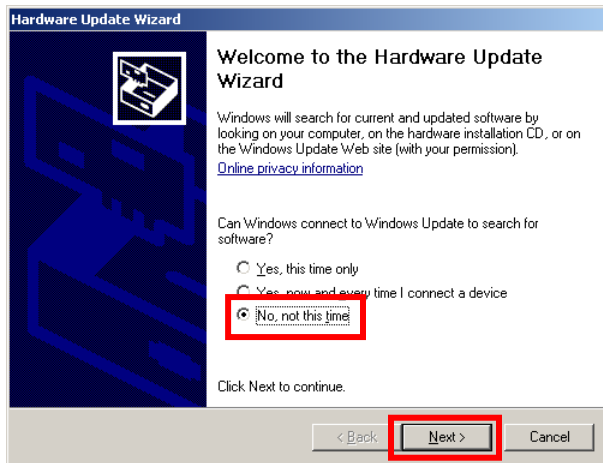

7 Select **Install from a list or specific location** and click **Next**.

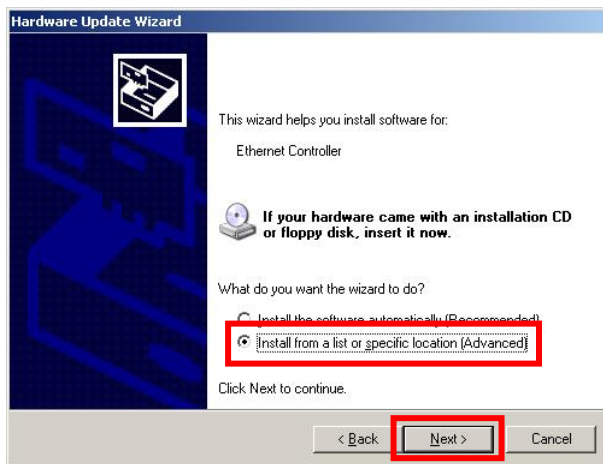



8 Mark **Include this location in the search**: check box, enter the followings and then click **Next**.

Compute Blade 2000:

Windows Server 2003(32bit): \X55x1\Win2003R2\Drivers\LAN\INTEL\_01\x86  
Windows Server 2003(x64) : \X55x1\Win2003R2\Drivers\LAN\INTEL\_01\x64

Compute Blade 320:

Windows Server 2003(32bit): \X51x5\Win2003R2\Drivers\LAN\INTEL\_01\x86  
Windows Server 2003(x64): \X51x5\Win2003R2\Drivers\LAN\INTEL\_01\x64

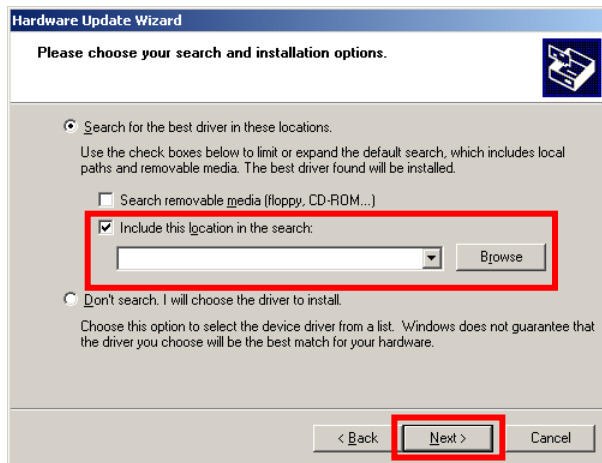

9 Click **Finish**.

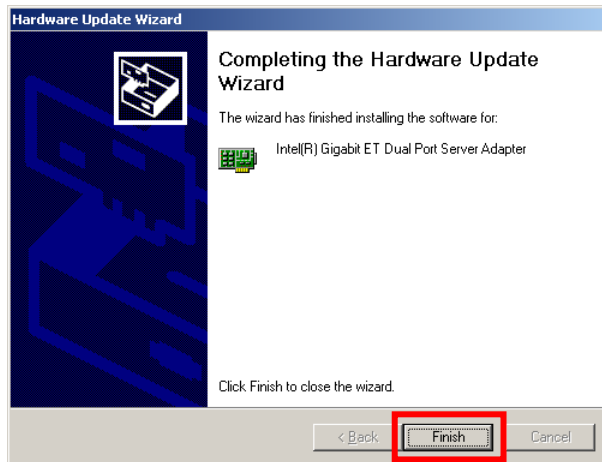

After completing the installation of OS driver, **Intel(R) Gigabit ET Dual Port Server Adapter** or **Intel(R) Gigabit ET Quad Port Server Adapter** or **Intel(R) Gigabit ET2 Quad Port Server Adapter** is displayed under the **Network adapters**.

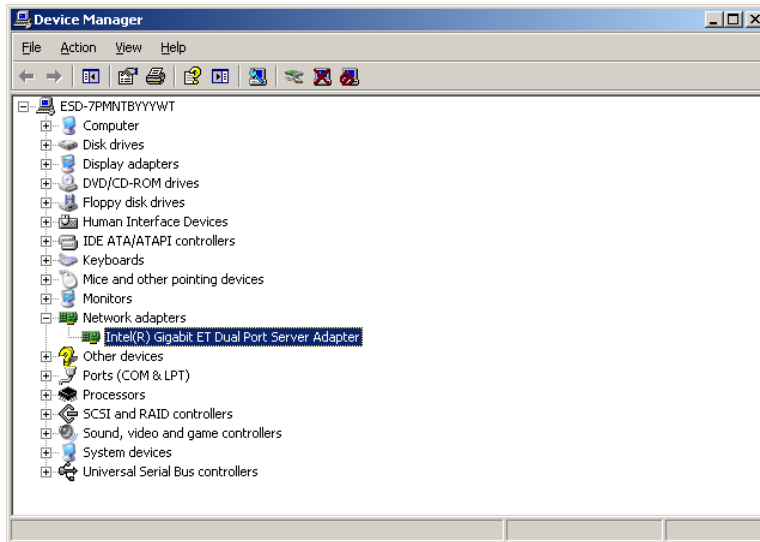

10 If there remain network adapters whose LAN driver has not been updated, repeat above Steps 5 to 9 for each network adapters.

11 Remove the CD-ROM from the CD/DVD drive, and reboot the blade server.

 It has been confirmed that communication using the TCP layer protocol may fail after installing Windows Server 2003 R2 SP2. See "Notes" on page 1-3..

## How to confirm the driver version (Windows Server 2003 R2)

- 1 Turn on the blade server, boot Windows Server 2003, and log on as "Administrator".
- 2 Click **Start - Control Panel - System**.
- 3 Click **Device Manager** under the **Hardware** tab.

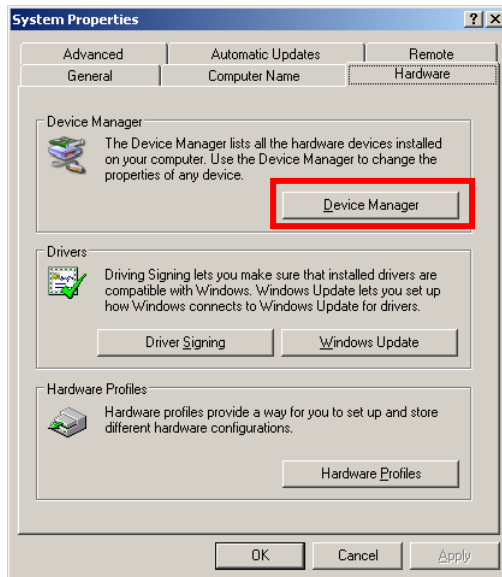

- 4 Right-click the **Intel(R) Gigabit ET Dual Port Server Adapter** or **Intel(R) Gigabit ET Quad Port Server Adapter** or **Intel(R) Gigabit ET2 Quad Port Server Adapter** under the **Network adapters** and click **Property**.

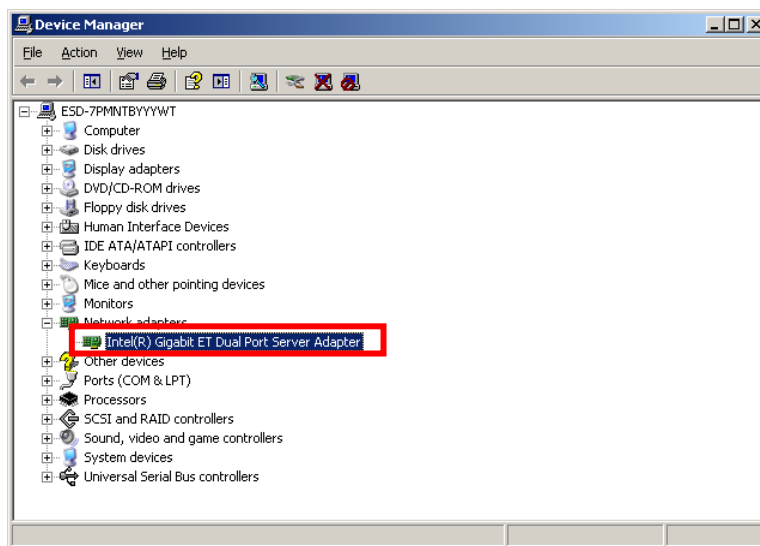

- 5 Click **Driver** tab, and confirm the version displayed on the right of "Driver Version;".

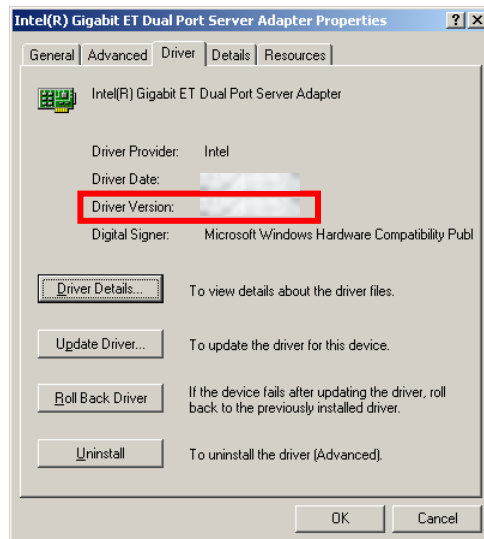

## How to install driver (Red Hat Enterprise Linux)

See the following documents for the procedure to setup drivers on Red Hat Enterprise Linux

- Compute blade 2000 : Hitachi Compute Blade 2000 SOFTWARE GUIDE
- Compute blade 320 : Hitachi Compute Blade 320 SOFTWARE GUIDE

## How to confirm the driver version (Red Hat Enterprise Linux)

- 1 Turn on the blade server, boot Red Hat Enterprise Linux, and log on as "root".
- 2 Execute the following command.

```
# modinfo igb
```

- 3 Confirm the version displayed in **version**.

```
filename:      /lib/modules/<Kernel Version>/kernel/drivers/net/igb/igb.ko
version:      xx.xx.xx
license:      GPL
description:  Intel(R) Gigabit Ethernet Network Driver
author:      Intel Corporation, <e1000-devel@lists.sourceforge.net>
```

## Utility

This chapter explains the setup of utility on Windows Server 2008 /Windows Server 2008 R2 and Windows Server 2003 R2.



The utility is not supported for Windows Server 2012 / Windows Server 2012 R2. Use the standard function of these OS's instead of the utility.

- [Outline](#)
- [How to install utility \(Windows Server 2008/Windows Server 2008 R2\)](#)
- [How to confirm the utility version \(Windows Server 2008/Windows Server 2008 R2\)](#)
- [How to install utility \(Windows Server 2003 R2\)](#)
- [How to confirm the utility version \(Windows Server 2003 R2\)](#)

## Outline

"Intel(R) PROSet" that is utility of the Compute Blade 2000/ Compute Blade 320 LAN adapter serves fault tolerant of LAN and Virtual LAN.



## How to install utility (Windows Server 2008/Windows Server 2008 R2)

1 Turn on the power of the blade server, boot Windows Server 2008/Windows Server 2008 R2, and then log on to the OS as a user with administrator privilege (such as Administrator).

2 Insert the driver media into the CD/DVD drive.

CB2000 : "Hitachi Compute Blade 2000 Driver Kit CD (12-10 or later)" or "Hitachi Server Navigator" or "Server installation and monitoring tool".

CB320 : "Hitachi Compute Blade Driver Kit (Version 05-04 or later)" or "Hitachi Server Navigator".

3 Click **Start - Run**.

4 Click **OK** with specifying the following files.

For Compute Blade 2000 (X55A2 model, X55E2 model) :

Using " Driver Kit" CD-ROM :

Windows Server 2008 R2, Windows Server 2008 64bit :

D:\X55x2\Win2008\Utility\PROSetDX\APPS\PROSETDX\Winx64\DxSetup.exe

Windows Server 2008 32bit :

D:\X55x2\Win2008\Utility\PROSetDX\APPS\PROSETDX\Win32\DxSetup.exe

Using "Hitachi Server Navigator" or "Server installation and monitoring tool" media :

Windows Server 2008 R2, Windows Server 2008 64bit :

D:\WinSrv2008\Utility\PROSet\PROSet\_03\APPS\PROSETDX\Winx64\Dxsetup.exe

Windows Server 2008 32bit :

D:\WinSrv2008\Utility\PROSet\PROSet\_03\APPS\PROSETDX\Win32\Dxsetup.exe

For Compute Blade 2000 (X57A1 model, X57E1 model) :

Using " Driver Kit" CD-ROM :

Windows Server 2008 R2, Windows Server 2008 64bit :

D:\X57x1\Win2008\Utility\PROSetDX\APPS\PROSETDX\Winx64\DxSetup.exe

Windows Server 2008 32bit :

D:\X57x1\Win2008\Utility\PROSetDX\APPS\PROSETDX\Win32\DxSetup.exe

Using "Hitachi Server Navigator" or "Server installation and monitoring tool" media :

Windows Server 2008 R2, Windows Server 2008 64bit :

D:\WinSrv2008\Utility\PROSet\PROSet\_03\APPS\PROSETDX\Winx64\Dxsetup.exe

For Compute Blade 320:

Using " Driver Kit" CD-ROM :

Windows Server 2008 R2 :

D:\X51x5\Win2008R2\Utility\PROSetDX\APPS\PROSETDX\Winx64\DxSetup.exe

Windows Server 2008 32bit :

D:\X51x5\Win2008\Utility\PROSetDX\APPS\PROSETDX\Vista32\DxSetup.exe

Windows Server 2008 64bit :

D:\X51x5\Win2008\Utility\PROSetDX\APPS\PROSETDX\Vistax64\DxSetup.exe

Using "Hitachi Server Navigator" media :

Windows Server 2008 R2, Windows Server 2008 64bit :

D:\WinSrv2008\Utility\PROSet\PROSet\_04\APPS\PROSETDX\Winx64\Dxsetup.exe

Windows Server 2008 32bit :

D:\WinSrv2008\Utility\PROSet\PROSet\_04\APPS\PROSETDX\Win32\Dxsetup.exe

5 Click **Next**.

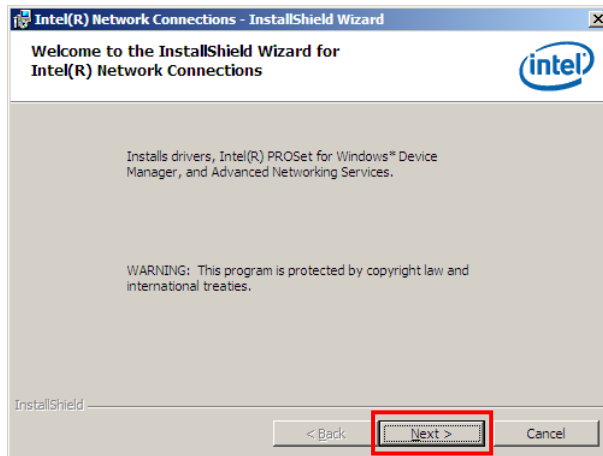

6 Read the License Agreement Terms. Select "I accept the terms in the license agreement" when you agree to the terms and click **Next**.

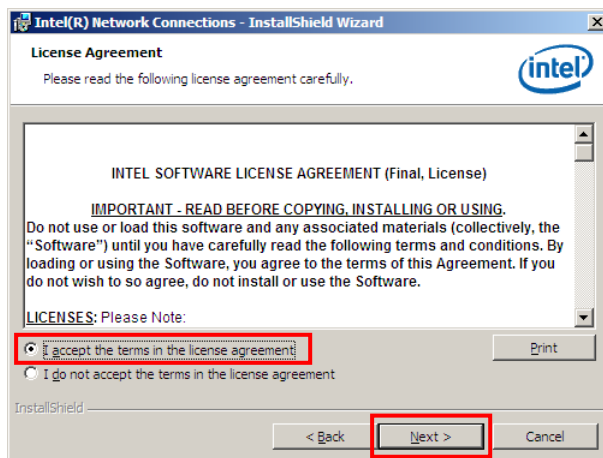

7 Check boxes of "Intel(R) PROSet for Windows\* Device Manager" and "Advanced Network Services", and click **Next**.

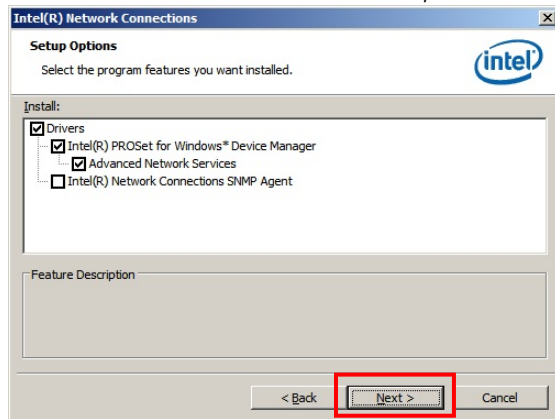

Do not check the box of "Intel(R) Network Connections SNMP Agent".

8 Click **Install**.

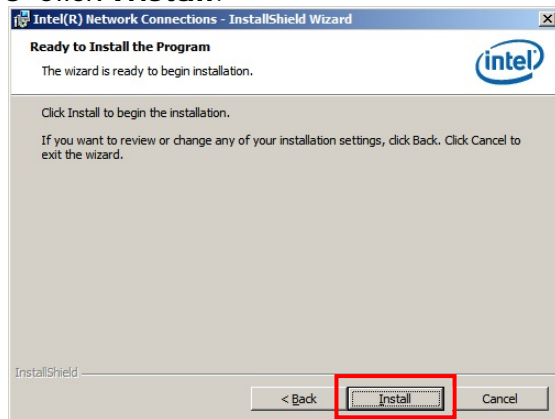

9 Click **Finish**.

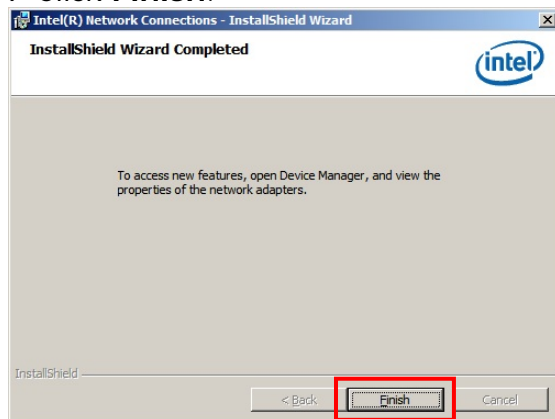

No problem if a warning message "WinMgmtWMI" is displayed after installing Intel(R) PROSet.

10 Reboot the blade server.

## How to confirm the utility version (Windows Server 2008/Windows Server 2008 R2)

- 1 Turn on the blade server, boot Windows Server 2008, and log on as "Administrator".
- 2 Click the **Start** button and select **Server Manager**.
- 3 Select **Diagnose** and then **Device Manager**.
- 4 Right-click the **Intel(R) Gigabit ET Dual Port Server Adapter** or **Intel(R) Gigabit ET Quad Port Server Adapter** or **Intel(R) Gigabit ET2 Quad Port Server Adapter** under the **Network adapter**, and click **Property**.

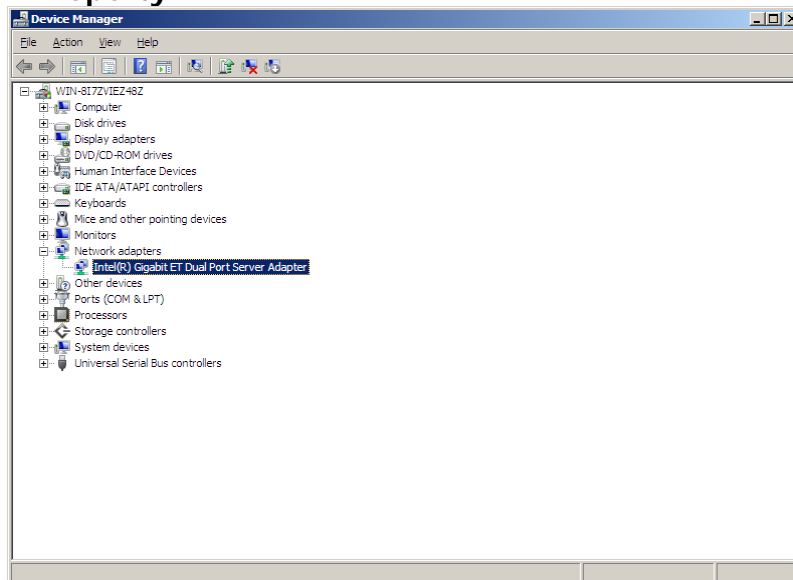

- 5 Click **Link Speed** tab, and confirm the version displayed on the right of **Intel(R) PROSet Version**. (The **Link Speed** tab is displayed after the utility is installed.)

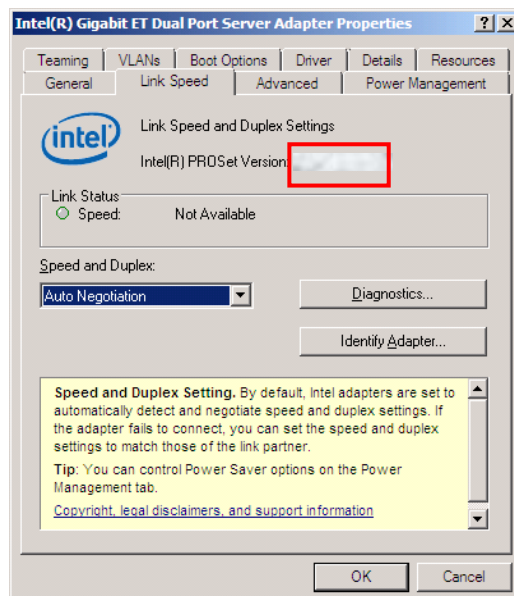

## How to install utility (Windows Server 2003 R2)

- 1 Turn on the power of the blade server, boot Windows Server 2003 R2, and then log on to the OS as a user with administrator privilege (such as Administrator).
- 2 Insert " Driver Kit" CD-ROM into the CD/DVD drive.  
CB2000 : Hitachi Compute Blade 2000 Driver Kit CD (12-10 or later)  
CB320 : Hitachi Compute Blade Driver Kit (Version 05-04 or later)

Click **Start - Run**.

- 3 Click **OK** with specifying the following files.

For Compute Blade 2000 (all models):

Windows Server 2003R2(32 bit) :

D:\X55x2\Win2003R2\Utility\PROSetDX\APPS\PROSETDX\Win32\DxSetup.exe

Windows Server 2003R2(x64) :

D:\X55x2\Win2003R2\Utility\PROSetDX\APPS\PROSETDX\Winx64\DxSetup.exe

For Compute Blade 320:

Windows Server 2003R2(32 bit) :

D:\X51x5\Win2003R2\Utility\PROSetDX\x86\APPS\PROSETDX\Win32\DxSetup.exe

Windows Server 2003R2(x64) :

D:\X51x5\Win2003R2\Utility\PROSetDX\x64\APPS\PROSETDX\Winx64\DxSetup.exe

- 4 Click **Next**.



- 5 Read the License Agreement Terms. Select "I accept the terms in the license agreement" when you agree to the terms and click **Next**.

- 6 Check boxes of "Intel(R) PROSet for Windows\* Device Manager" and "Advanced Network Services", and click **Next**.

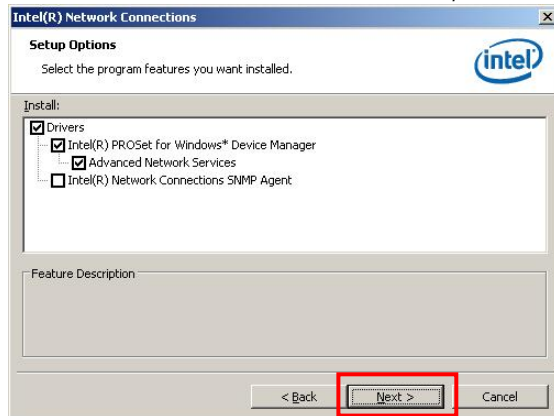

Do not check the box of "Intel(R) Network Connections SNMP Agent".

- 7 Click **Install**.

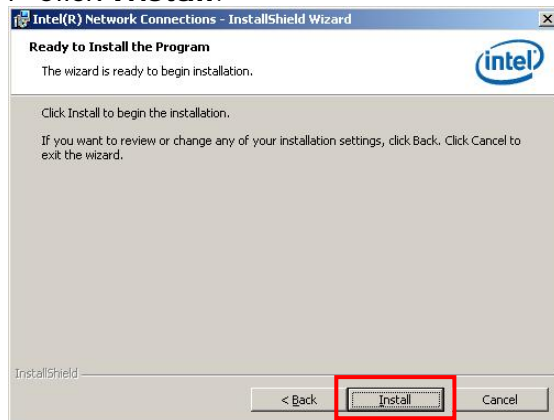

- 8 Click **Finish**.

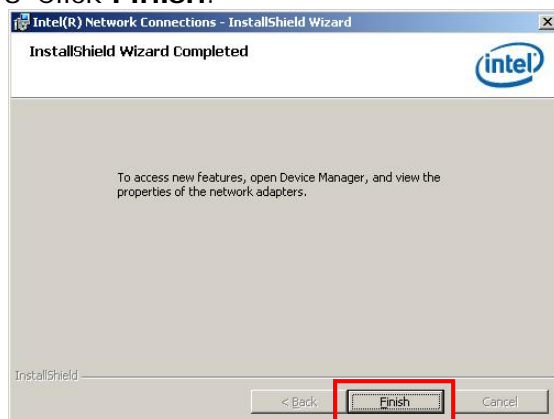

- 9 Reboot the system.

## How to confirm the utility version (Windows Server 2003 R2)

- 1 Turn on the blade server, boot Windows Server 2003, and log on as "Administrator".
- 2 Click **Start - Control Panel - System**.
- 3 Click **Device Manager** under the **Hardware** tab

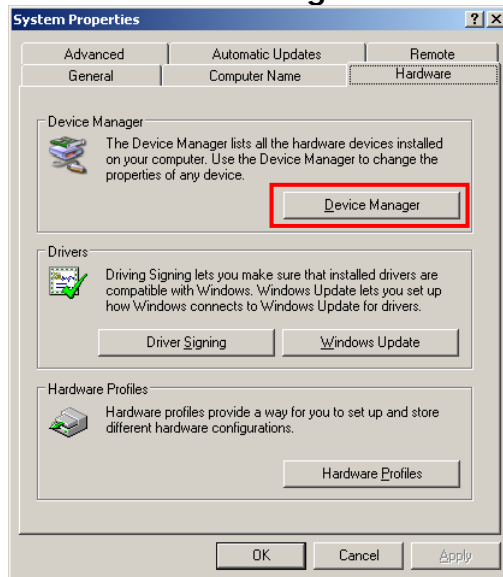

- 4 Right-click the **Intel(R) Gigabit ET Dual Port Server Adapter** or **Intel(R) Gigabit ET Quad Port Server Adapter** or **Intel(R) Gigabit ET2 Quad Port Server Adapter** under the **Network adapter** and click **Property**.

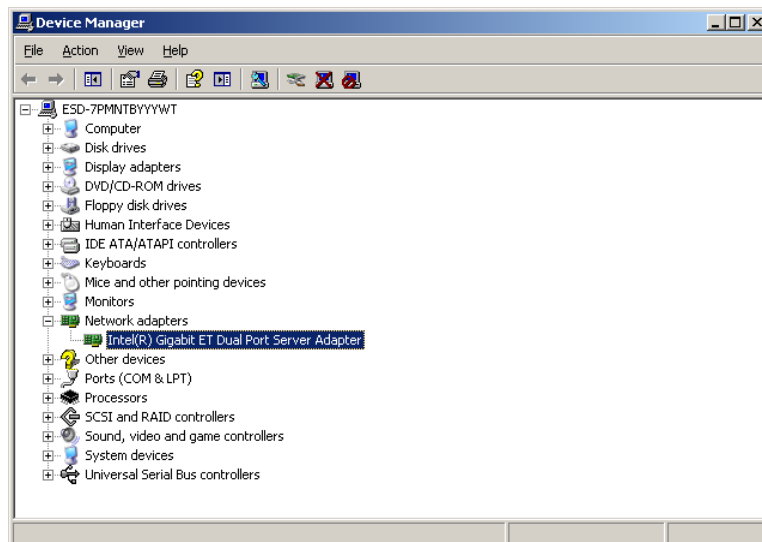

5 Click **Link Speed** tab.



After utility is installed, the link speed tab is displayed.

6 Confirm the version displayed in **Intel(R) PROSet Version**.

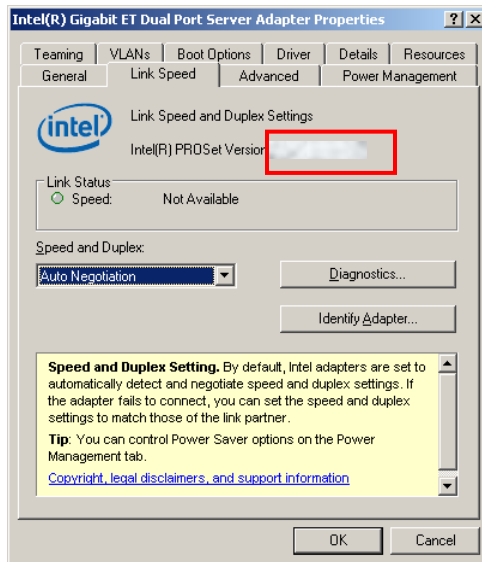



# LAN Advanced Functions

This chapter explains the setting of LAN advanced functions using the utility of the Compute Blade 2000/ Compute Blade 320 LAN adapter.

- [Details of LAN advanced function \(Compute Blade 2000\)](#)
- [Details of LAN advanced function \(Compute Blade 320\)](#)

## Details of LAN advanced function (Compute Blade 2000)

See "Compute Blade 2000 SOFTWARE GUIDE" for the LAN advanced function.

## Details of LAN advanced function (Compute Blade 320)

See "Compute Blade 320 SOFTWARE GUIDE" for the LAN advanced function.



# Specification

This chapter describes the basic specification of the LAN adapters.

- [Basic Specification \(2-port 1000Base-T LAN Adapter\)](#)
- [Basic Specification \(4-port 1000Base-T LAN Adapter\)](#)
- [Basic Specification \(4-port 1000Base-T LAN Adapter \(ET2\)\)](#)

## Basic Specification (2-port 1000Base-T LAN Adapter)

The basic specifications of 2-port 1000Base-T LAN Adapter are listed below.

Item	Specification	Notes
Product Code	CB2000 : GVX-CN2N1G1X1[BX] GVX-CN2D1G1X1 [EX] GV-CN2N1G1X1-Y GV-CN2N1G1XR-Y GV-CN2D1G1X1-Y CB 320 : GGX-CN9P1G1X1[EX] GG-CN9P1G2X1-Y	
LAN Controller	Intel 82576	
Vender ID	8086	
Device ID	10C9	
SubSystem ID	A01C	
SubVender ID	8086	
PCI Interface	PCI Express 2.0	
Lane Speed	2.5GT/s	
Number of Lane	4 line	
Connecter Type	PCI Express x4	
PCI Slot Type	PCI Express x4, x8	
LAN Interface	IEEE802.3ab 1000Base-T	
Speed	10/100/1000Mbps	
Number of Port	2	
Connecter Type	RJ-45	
Cable Type	Cat-6 (10/100/1000Mbps) Cat-5E (10/100/1000Mbps) Cat-5 (10/100Mbps)	
Cable	100m	Maximum
LED	ACT/LNK, 10/100/1000	2 each
Wake On LAN PXE Boot	Not supported	Not allow to use the function because it has been supported on onboard LAN already.
Applying Standard	VCCI (Class A) FCC (Class B),UL, CE, MIC	
Operating Temperature	0C ~ 55C	
Operating Humidity	20% ~ 80%	Non-condensing
Storage Temperature	-40C ~ 70C	
Storage Humidity	20% ~ 90%	Non-condensing
Power Supply	3.3V, 3.3Vaux, 12V (+/-5%)	
Consumption Current	2.9W	Maximum
Dimension	H: 79.2mmxL: 167.4mmxW:21.5mm	
Weight	0.1kg Approx.	
RoHS Compliance	In compliance with RoHS regulation	Pb free

## Basic Specification (4-port 1000Base-T LAN Adapter)

The basic specifications of 4-port 1000Base-T LAN Adapter are listed below.

Item	Specification	Notes
Product Code	CB 2000 : GVX-CN2N1G2X1[BX] GVX-CN2D1G2X1[EX] GV-CN2N1G2X1-Y GV-CN2D1G2X1-Y CB 320 : GGX-CN9P1G2X1[EX] GG-CN9P1G2X1-Y	
LAN Controller	Intel 82576	
Vendor ID	8086	
Device ID	10E8	
SubSystem ID	A02C	
SubVendor ID	8086	
PCI Interface	PCI Express 2.0	
Lane Speed	2.5GT/s	
Number of Lane	4 line	
Connector Type	PCI Express x4	
PCI Slot Type	PCI Express x4, x8	
LAN Interface	IEEE802.3ab 1000Base-T	
Speed	10/100/1000Mbps	
Number of Port	4	
Connector Type	RJ-45	
Cable Type	Cat-6 (10/100/1000Mbps) Cat-5E (10/100/1000Mbps) Cat-5 (10/100Mbps)	
Cable	100m	Maximum
LED	ACT/LNK, 10/100/1000	4 each
Wake On LAN PXE Boot	Not supported	Not allow to use the function because it has been supported on onboard LAN already.
Applying Standard	VCCI (Class A) FCC (Class B) UL、CE、MIC	
Operating Temperature	0C ~ 55C	
Operating Humidity	20% ~ 80%	Non-condensing
Storage Temperature	-40C ~ 70C	
Storage Humidity	20% ~ 90%	Non-condensing
Power Supply	3.3V,3.3Vaux,12V (±5%)	
Consumption Current	8.4A	Maximum
Dimension	H: 79.2mm×L: 167.4mm×W:21.5mm	
Weight	0.1kg Approx.	
RoHS Compliance	In compliance with RoHS regulation	Pb free

## Basic Specification (4-port 1000Base-T LAN Adapter(ET2))

The basic specifications of 4-port 1000Base-T LAN Adapter(ET2) are listed below.

Item	Specification	Notes
Product Code	CB 2000 : GVX-CN2N1G3X1[BX] GVX-CN2D1G3X1[EX] GV-CN2N1G3X1-Y GV-CN2N1G3XR-Y GV-CN2D1G3X1-Y CB 320 : GGX-CN9P1G2X2[EX] GG-CN9P1G2X2-Y	
LAN Controller	Intel 82576	
Vendor ID	8086	
Device ID	1526	
SubSystem ID	A05C	
SubVendor ID	8086	
PCI Interface	PCI Express 2.0	
Lane Speed	2.5GT/s	
Number of Lane	4 line	
Connector Type	PCI Express x4	
PCI Slot Type	PCI Express x4, x8	
LAN Interface	IEEE802.3ab 1000Base-T	
Speed	10/100/1000Mbps	
Number of Port	4	
Connector Type	RJ-45	
Cable Type	Cat-6 (10/100/1000Mbps) Cat-5E (10/100/1000Mbps) Cat-5 (10/100Mbps)	
Cable	100m	Maximum
LED	ACT/LNK, 10/100/1000	4 each
Wake On LAN PXE Boot	Not supported	Not allow to use the function because it has been supported on onboard LAN already.
Applying Standard	VCCI (Class A) FCC (Class B) UL、CE、MIC	
Operating Temperature	0C ~ 55C	
Operating Humidity	20% ~ 80%	Non-condensing
Storage Temperature	-40C ~ 70C	
Storage Humidity	20% ~ 90%	Non-condensing
Power Supply	3.3V,3.3Vaux,12V (±5%)	
Consumption Current	8.4A	Maximum
Dimension	H: 79.2mm×L: 167.4mm×W:21.5mm	
Weight	0.1kg Approx.	
RoHS Compliance	In compliance with RoHS regulation	Pb free





## **Hitachi Data Systems**

### **Corporate Headquarters**

2845 Lafayette Street  
Santa Clara, California 95050-2639  
U.S.A.  
[www.hds.com](http://www.hds.com)

### **Regional Contact Information**

#### **Americas**

+1 408 970 1000  
[info@hds.com](mailto:info@hds.com)

#### **Europe, Middle East, and Africa**

+44 (0) 1753 618000  
[info.emea@hds.com](mailto:info.emea@hds.com)

#### **Asia Pacific**

+852 3189 7900  
[hds.marketing.apac@hds.com](mailto:hds.marketing.apac@hds.com)

