



Hitachi Universal Storage Platform V Hitachi Universal Storage Platform VM

Hitachi SNMP Agent User and Reference Guide

FASTFIND LINKS

[Document Organization](#)

[Product Version](#)

[Getting Help](#)

[Contents](#)

© 2011 Hitachi, Ltd., Hitachi Data Systems Corporation. All rights reserved.

No part of this publication may be reproduced or transmitted in any form or by any means, electronic or mechanical, including photocopying and recording, or stored in a database or retrieval system for any purpose without the express written permission of Hitachi, Ltd. (hereinafter referred to as "Hitachi"), and Hitachi Data Systems Corporation (hereinafter referred to as "Hitachi Data Systems").

Hitachi and Hitachi Data Systems reserve the right to make changes to this document at any time without notice and assume no responsibility for its use. This document contains the most current information available at the time of publication. When new or revised information becomes available, this entire document will be updated and distributed to all registered users.

Some of the features described in this document may not be currently available. Refer to the most recent product announcement or contact your local Hitachi Data Systems sales office for information about feature and product availability.

Notice: Hitachi Data Systems products and services can be ordered only under the terms and conditions of the applicable Hitachi Data Systems agreements. The use of Hitachi Data Systems products is governed by the terms of your agreements with Hitachi Data Systems.

Hitachi is a registered trademark of Hitachi, Ltd., in the United States and other countries. Hitachi Data Systems is a registered trademark and service mark of Hitachi, Ltd., in the United States and other countries.

Dynamic Provisioning, ShadowImage, and TrueCopy are registered trademarks or trademarks of Hitachi Data Systems.

IBM, AIX, and z/OS are registered trademarks of International Business Machines Corporation.

All other trademarks, service marks, and company names are properties of their respective owners.

Microsoft product screen shots reprinted with permission from Microsoft Corporation.



Contents

Preface.....	V
Intended Audience	vi
Product Version.....	vi
Document Revision Level	vi
Source Document(s) for this Revision	vii
Changes in this Revision	vii
Document Organization	vii
Referenced Documents.....	vii
Document Conventions.....	viii
Convention for Storage Capacity Values	ix
Getting Help	ix
Comments.....	ix
Overview of SNMP.....	1-1
SNMP Manager Overview	1-2
SNMP Manager and SNMP Agent Interaction.....	1-2
Management Information Base	1-3
SNMP Agent Overview	1-4
System Configuration.....	1-4
SNMP Agent Functions	1-5
SNMP Manager Functions.....	1-7
Component Status Information	1-7
Using the SNMP GUI.....	2-1
SNMP Information Tab	2-2
Performing SNMP Operations.....	3-1
Adding SNMP Manager IP Addresses.....	3-2
Deleting SNMP Manager IP Addresses.....	3-3

Adding a Community Name	3-4
Deleting a Community Name	3-6
Changing a Community Name	3-7
Adding a Community IP Address	3-9
Deleting a Community IP Address	3-11
Testing the SNMP Trap Report.....	3-12
SNMP Supported MIB	4-1
Trap Configuration.....	4-2
Extension Trap Specifications.....	4-2
Extension Trap Protocol Data Unit	4-3
Standard MIB Specifications	4-4
Supported MIB	4-4
MIB Access Mode.....	4-4
Object Identifier System	4-4
Supported Traps	4-6
MIB Mounting Specifications	4-6
Extension MIB Specifications	4-7
Extension MIB Configuration	4-7
Extension MIB Configuration.....	4-14
SNMP Failure Trap Reference	5-1
SNMP Failure Trap Reference Codes.....	5-2
Troubleshooting	6-1
Mitigating SNMP Errors	6-2
Calling the Hitachi Data Systems Support Center.....	6-3

Acronyms and Abbreviations

Index



Preface

This document describes and provides instructions for performing Hitachi SNMP Agent operations on the Hitachi Universal Storage Platform V and Hitachi Universal Storage Platform VM (USP V/VM) storage systems.

Please read this document carefully to understand how to use this product, and maintain a copy for reference purposes.

This preface includes the following information:

- [Intended Audience](#)
- [Product Version](#)
- [Document Revision Level](#)
- [Source Document\(s\) for this Revision](#)
- [Changes in this Revision](#)
- [Document Organization](#)
- [Referenced Documents](#)
- [Document Conventions](#)
- [Convention for Storage Capacity Values](#)
- [Getting Help](#)
- [Comments](#)

Notice: The use of Hitachi SNMP Agent software and all other Hitachi Data Systems products is governed by the terms of your agreement(s) with Hitachi Data Systems.

Intended Audience

This document is intended for system administrators, Hitachi Data Systems representatives, and Authorized Service Providers who are involved in installing, configuring, and operating the Hitachi Universal Storage Platform V and VM storage system.

This document assumes the following:

- The user has a background in data processing and understands RAID storage systems and their basic functions.
- The user is familiar with the Universal Storage Platform V and/or VM storage system and has read the *Universal Storage Platform V/VM User and Reference Guide*.
- The user is familiar with the Storage Navigator software for the Universal Storage Platform V/VM and has read the *Storage Navigator User's Guide*.
- The user is familiar with the operating system and web browser software on the system hosting the Storage Navigator software.

Product Version

This document revision applies to Universal Storage Platform V/VM microcode 60-08-0x and higher.

Document Revision Level

Revision	Date	Description
MK-96RD620-P	February 2007	Preliminary Release
MK-96RD620-00	April 2007	Initial Release, supersedes and replaces MK-96RD620-P
MK-96RD620-01	May 2007	Revision 1, supersedes and replaces MK-96RD620-00
MK-96RD620-02	September 2007	Revision 2, supersedes and replaces MK-96RD620-01
MK-96RD620-03	November 2007	Revision 3, supersedes and replaces MK-96RD620-02
MK-96RD620-04	March 2008	Revision 04, supersedes and replaces MK-96RD620-03
MK-96RD620-05	May 2008	Revision 05, supersedes and replaces MK-96RD620-04
MK-96RD620-06	August 2008	Revision 06, supersedes and replaces MK-96RD620-05
MK-96RD620-07	November 2008	Revision 07, supersedes and replaces MK-96RD620-06
MK-96RD620-08	January 2009	Revision 08, supersedes and replaces MK-96RD620-07
MK-96RD620-09	June 2009	Revision 09, supersedes and replaces MK-96RD620-08
MK-96RD620-10	November 2009	Revision 10, supersedes and replaces MK-96RD620-09
MK-96RD620-11	January 2010	Revision 11, supersedes and replaces MK-96RD620-10
MK-96RD620-12	July 2010	Revision 12, supersedes and replaces MK-96RD620-11
MK-96RD620-13	April 2011	Revision 13, supersedes and replaces MK-96RD620-12

Source Documents for this Revision

- MK-96RD620-12
- MK-96RD621-13a

Changes in this Revision

- Added two new SNMP failure trap reference codes pertaining to drive errors (one for external volume write error, and a second for external volume read error) (see [Table 5-1](#)).

Document Organization

The following table provides an overview of the contents and organization of this document. Click the [chapter title](#) in the left column to go to that chapter. The first page of each chapter provides links to the sections in that chapter.

Chapter	Description
Overview of SNMP	Provides an overview of SNMP including an overview of the agent and management functions.
Using the SNMP GUI	Describes the SNMP information tab.
Performing SNMP Operations	Provides instructions for adding and deleting an SNMP manager IP address, adding and deleting a community name, and adding and deleting a community IP address.
SNMP Supported MIB	Explains the MIB specifications, standard and extension, SNMP GUI, and trap configuration.
SNMP Failure Trap Reference	Shows the alert level, trap reference code, description, and alert level.
Troubleshooting	Provides troubleshooting information for the Hitachi SNMP Agent.
Acronyms and Abbreviations	Defines the acronyms and abbreviations used in this document.
Index	Lists the topics in this document in alphabetical order.

Referenced Documents

Hitachi Universal Storage Platform V/VM:

- *Storage Navigator User's Guide*, MK-96RD621
- *User and Reference Guide*, MK-96RD635





Document Conventions

The terms “Universal Storage Platform V” and “Universal Storage Platform VM” refer to all models of the Hitachi Universal Storage Platform V and VM storage systems, unless otherwise noted.

This document uses the following typographic conventions:

Convention	Description
Bold	Indicates text on a window, other than the window title, including menus, menu options, buttons, fields, and labels. Example: Click OK .
<i>Italic</i>	Indicates a variable, which is a placeholder for actual text provided by the user or system. Example: copy <i>source-file target-file</i> Note: Angled brackets (< >) are also used to indicate variables.
screen/code	Indicates text that is displayed on screen or entered by the user. Example: # pairdisplay -g oradb
< > angled brackets	Indicates a variable, which is a placeholder for actual text provided by the user or system. Example: # pairdisplay -g <group> Note: Italic font is also used to indicate variables.
[] square brackets	Indicates optional values. Example: [a b] indicates that you can choose a, b, or nothing.
{ } braces	Indicates required or expected values. Example: { a b } indicates that you must choose either a or b.
vertical bar	Indicates that you have a choice between two or more options or arguments. Examples: [a b] indicates that you can choose a, b, or nothing. { a b } indicates that you must choose either a or b.
underline	Indicates the default value. Example: [<u>a</u> b]

This document uses the following icons to draw attention to information:

Icon	Meaning	Description
	Note	Calls attention to important and/or additional information.
	Tip	Provides helpful information, guidelines, or suggestions for performing tasks more effectively.
	Caution	Warns the user of adverse conditions and/or consequences (e.g., disruptive operations).
	WARNING	Warns the user of severe conditions and/or consequences (e.g., destructive operations).

Convention for Storage Capacity Values

Physical storage capacity values (e.g., disk drive capacity) are calculated based on the following values:

- 1 KB = 1,000 bytes
- 1 MB = 1,000² bytes
- 1 GB = 1,000³ bytes
- 1 TB = 1,000⁴ bytes
- 1 PB = 1,000⁵ bytes

Logical storage capacity values (for example, logical device capacity) are calculated based on the following values:

- 1 KB = 1,024 (2¹⁰) bytes
- 1 MB = 1,024 KB or 1,024² bytes
- 1 GB = 1,024 MB or 1,024³ bytes
- 1 TB = 1,024 GB or 1,024⁴ bytes
- 1 PB = 1,024 TB or 1,024⁵ bytes
- 1 block = 512 bytes

Getting Help

If you need to call the Hitachi Data Systems Support Center, make sure to provide as much information about the problem as possible, including:

- The circumstances surrounding the error or failure.
- The content of any error message(s) displayed on the host system(s).
- The content of any error message(s) displayed on Storage Navigator.
- The Storage Navigator configuration information (use the FD Dump Tool).
- The service information messages (SIMs), including reference codes and severity levels, displayed by Storage Navigator.

The Hitachi Data Systems customer support staff is available 24 hours/day, seven days a week. If you need technical support, please call:

- United States: (800) 446-0744
- Outside the United States: (858) 547-4526

Comments

Please send us your comments on this document: doc.comments@hds.com. Include the document title, number, and revision, and refer to specific section(s) and paragraph(s) whenever possible.

Thank you! (All comments become the property of Hitachi Data Systems.)

Overview of SNMP

This chapter provides an overview of SNMP including an overview of the agent and management functions:

- [SNMP Manager Overview](#)
- [SNMP Agent Overview](#)
- [SNMP Manager Functions](#)

SNMP Manager Overview

SNMP Manager and SNMP Agent Interaction

Figure 1-1 shows an SNMP environment.

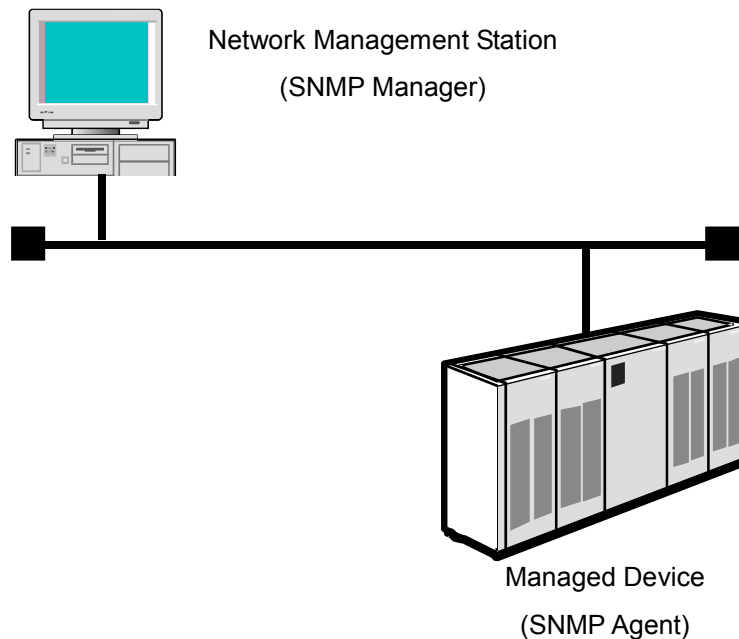

Figure 1-1 SNMP Environment

Simple Network Management Protocol (SNMP) is an industry-standard protocol for managing and monitoring network devices, including disk devices, routers, and hubs. SNMP uses Simple Gateway Management Protocol (SGMP) to manage the TCP/IP gateways.

The standardized configuration and database of network management information is called a Management Information Base (MIB). A standard MIB is common to all SNMP interfaces. An extension MIB is defined by the particular managed device or protocol.

An SNMP manager monitors the devices, which are referred to as managed nodes. The primary types of interaction between the SNMP manager and an SNMP agent are **polling** and **trap**. Typically, the SNMP manager polls the SNMP agents on a periodic basis, to determine whether the device is operating normally. If an abnormal event occurs, the SNMP Agent can report the condition without a request from the manager, by using a message called trap.

When an SNMP Manager polls the agent, the following dialogue takes place:

- An SNMP manager sends a request packet to an SNMP agent, which requests data regarding the status of the managed node.
- The SNMP agent sends a response packet back to the SNMP manager.
- SNMP uses the TCP/IP User Datagram Protocol (UDP). If the SNMP agent does not respond within a specified time period, the SNMP manager re-sends the request packet. That time period is set by the system administrator, taking into account the network traffic and operation policy.
- If an SNMP agent again does not respond to the resent packet, the SNMP manager assumes that an error has occurred. Depending on the times set for polling and response, this can take several seconds.

If an SNMP agent detects an abnormal event, it sends a trap to the SNMP manager. However, if a trap is dropped in transmission, the SNMP manager does not know that it was sent. For this reason, you should use both polling and traps to determine whether an abnormal event has occurred.

Management Information Base

Each managed device has certain types of information, including the configuration information, the status information of the device, and statistical, which is known collectively as a Management Information Base (MIB). Each parameter is called a managed object, and it consists of the parameter name, one or more parameter(s), and a group of operations that can be executed with the object. The MIB defines the type of information that can be obtained from a managed device, and the device settings that can be controlled from a management system.

SNMP Agent Overview

System Configuration

The SNMP agent Hitachi Universal Storage Platform V and Hitachi Universal Storage Platform VM (Hereinafter referred to as USP V/VM) is on the service processor (SVP), which is the computer within the storage array that manages the storage system. The USP V/VM has an exclusive LAN for communications between a storage system and a service processor, and a separate LAN for SNMP. The configuration of each Network Management Station is determined by the type of SNMP Manager. Figure 1-2 illustrates the SNMP environment. Figure 1-3 shows an example of SNMP operations by using an SNMP manager.

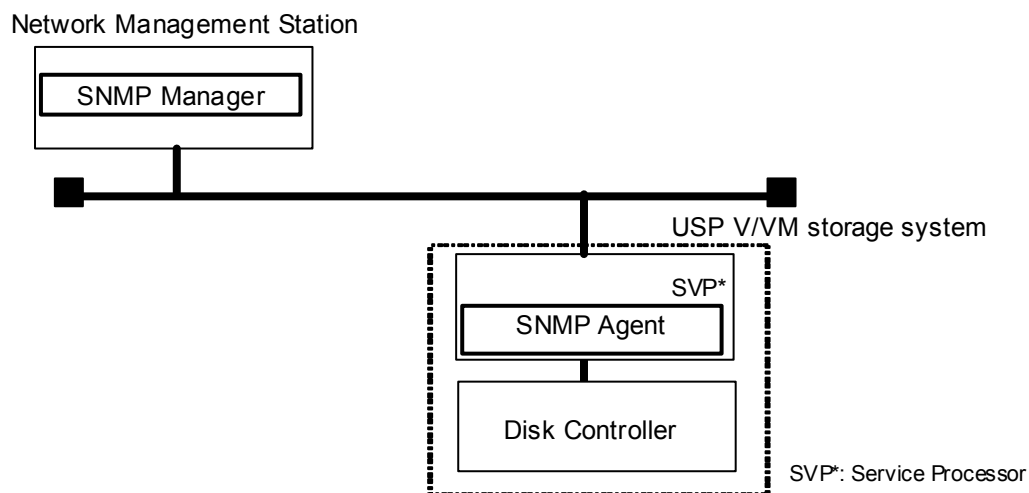

Figure 1-2 SNMP Environment Architecture

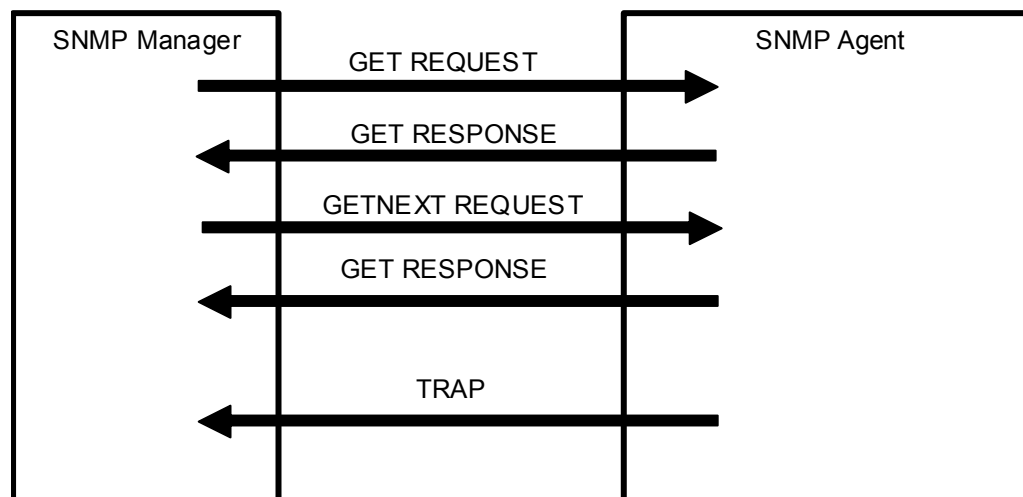

Figure 1-3 Example of SNMP Operations

SNMP Agent Functions

SNMP Traps

An SNMP agent reports a storage system error to SNMP manager using the trap report function.

If an error occurs, an SNMP agent issues an SNMP trap to an SNMP manager to report a failure. Issuing an SNMP trap, an SNMP agent also reports a product number, nickname, reference code, and an identifier of the component.

Table 1-1 lists the events that trigger an SNMP agent trap.

Table 1-1 SNMP Trap Triggering Events

Events	Description
Acute failure detected.	All operations in a subsystem stopped.
Serious failure detected.	Operation in a component where a failure occurred stopped.
Moderate failure detected.	Partial failure.
Service failure detected.	Minor failure.

An SNMP agent logs the most recent 256 traps, so you can see the trap history of a particular device.

SNMP Agent Operations

Table 1-2 lists the types SNMP Agent operations.

Table 1-2 SNMP Agent Operations

Operation	Description
GET	Obtains a specific MIB object value. GET REQUEST is the request from an SNMP manager, and GET RESPONSE is the agent's response to that request.
GETNEXT	Continuously finds a MIB object. GETNEXT REQUEST is the request from an SNMP manager, and GETNEXT RESPONSE is the agent's response to that request.
TRAP	Reports an event (failure) to an SNMP manager. TRAP occurs without a request from the SNMP manager.

Error Report

Table 1-3 lists the errors to be reported for the REQUEST operations.

Table 1-3 SNMP Agent REQUEST Operations

Error	Description	Corrective Action
noError(0)	Normal	N/A
noSuchName(2)	<ul style="list-style-type: none">There are no MIB objects that are required. (Not supported).The GETNEXT REQUEST command that is specified for the following object identifier of the last supported MIB object is received.	Verify that the requested object is correct.
readOnly(4)	SET REQUEST is received.	SET operation is not supported.
genErr(5)	Error occurred for other reasons.	Retry the operation.

SNMP Manager Functions

Component Status Information

You can obtain the status information of certain storage system components from an SNMP manager. Table 1-4 lists the components for which the status can be obtained.

Table 1-4 Available Component Status Information

Area	Component Name
Storage System	Processor
	BUS
	Cache
	Shared memory
	Power supply
	Battery
	Fan
	Others
Disk Unit	Power supply
	Fan
	Others
	Hard disk drive

Table 1-5 lists the subsystem component status as well as the trap report function.

Table 1-5 Subsystem Component Status Types

Status	Description
Normal	Normal operation.
Acute failure detected	All operations in a subsystem stopped.
Serious failure detected	Operation in a component where a failure occurred stopped.
Moderate failure detected	Partial failure.
Service failure detected	Minor failure.

Using the SNMP GUI

This chapter describes the SNMP information tab:

- [SNMP Information Tab](#)

SNMP Information Tab

1. Click **Go** – Environmental Settings – SNMP Information in the menu bar of the **Storage Navigator Main** window.
2. Select the **SNMP Information tab** (see Figure 2-1).

Option buttons (left side of the window) and storage system information icons (window upper right corner) have been omitted from the screen shot. See the *Storage Navigator User's Guide* for an illustration.

The screenshot shows the 'SNMP Information' tab in a software interface. At the top, there are several tabs: 'License Key', 'SNMP Information', 'E-mail Information', 'Partition Definition', and 'License Key Partition Definition'. The 'SNMP Information' tab is selected. Below the tabs, there is a section titled 'SNMP Information' with a sub-section 'Install' containing a checked checkbox for 'Extension SNMP'. A table with the header 'Manager' lists two IP addresses: 192.168.1.1 and 192.169.1.1. To the right of this table is a 'Community & Trap' section with a tree view showing a 'Community' folder containing a 'public' entry. Below these sections is an 'IP Address' field with radio buttons for 'IPv4' and 'IPv6', and a 'Set' button. The bottom section is titled 'System Group' and contains three fields: 'Name' (RAID-H601), 'Contact' (SVP), and 'Location' (2F-8). At the very bottom, there are three buttons: 'Trap Test', 'Apply', and 'Cancel'.

Figure 2-1 SNMP Information Tab

Item	Description
Install	The Extension SNMP checkbox is selected if the SNMP Agent feature is enabled. To set the SNMP Agent properties from Storage Navigator PC, select Extension SNMP on SNMP Information window.
Manager	The Manager section allows you to add and delete SNMP manager information (see Adding SNMP Manager IP Addresses).
IP Address list box	Displays the IP addresses of registered SNMP managers from which the SNMP agent accepts requests. If no manager is registered, the SNMP agent accepts requests from all managers. You can register up to 32 managers
IP Address text box	<p>Enter the IP address of the manager that the SNMP Agent receives the request from.</p> <ul style="list-style-type: none"> ▪ Ipv4 and Ipv6 addresses can be specified for IP Address. However, if the OS of SVP is Windows XP and you enter the Ipv6 address and select Apply, an error message is displayed and the Ipv6 address is not set. ▪ Any IP address having all values set to zero (0) cannot be specified for Ipv4 and Ipv6. ▪ The Ipv4 address is specified by entering four numbers that are separated by periods (.) using a maximum of three digits from zero (0) to 255 inclusive. (For example: XXX.XXX.XXX.XXX when X is a number). Enter the numbers only and do not enter periods. ▪ The Ipv6 address is specified by entering eight hexadecimal numbers that are separated by colons (:) using a maximum of 4 digits from zero (0) to FFFF inclusive. (For example: YYYY:YYYY:YYYY:YYYY:YYYY:YYYY:YYYY:YYYY when Y is a hexadecimal number). Enter the hexadecimal numbers only, and do not enter the colons. The cursor can be moved between the entry fields using the Tab key.
Ipv4 radio box	Is selected when entering an Ipv4 address. The Ipv4 address can be entered to IP address text box when this radio box is selected.
Ipv6 radio box	Is selected when entering an Ipv6 address. The Ipv6 address can be entered to the IP address text box when this radio box is selected.
Set	Adds new IP addresses to the IP Address list box.
Community & Trap	<p>Allows you to add, delete, or change SNMP trap information. The registered IP address is the trap destination for the specified community.</p> <ul style="list-style-type: none"> ▪ Each community can have more than one defined IP address (see Adding a Community Name and Adding a Community IP Address). ▪ You can register up to 32 community names and up to 32 IP addresses per community name. ▪ You can use up to 180 alphanumeric characters for a community name. You cannot use the following: ", \, ;, :, ,, *, ?, <, >, , /, ^, &, %, and a space before or after the community name.
System Group	<p>Allows you to add, delete or change SNMP system group information. If system group information has already been registered, the registered information displays. To register the system group information, the Extension SNMP checkbox must be selected. When you register system group information, select Apply. System group information is as follows:</p> <ul style="list-style-type: none"> ▪ Name: Connected subsystem device name. Storage Navigator users can change the device name. You can use up to 180 alphanumeric characters for a device name. You cannot use the following: ", \, ;, :, ,, *, ?, <, >, , /, ^, &, %, .You can use a space in the middle of the device name, but not before and after and a space before or after the device name. <p>The device name is required to use SNMP Agent. Make sure to document the device name, because settings will be cleared when SVP is replaced.</p>

Item	Description
	<ul style="list-style-type: none"> <li data-bbox="570 216 1414 436">▪ Contact: Contact information such as personnel and telephone numbers where you can inquire about the connected subsystem. Storage Navigator users can change contact information in Modify mode. Enter contact information using up to 180 alphanumeric characters (ASCII codes), except for some symbols, such as ", \, ;, :, ,, *, ?, <, >, , /, ^, &, and %. You can also use a space, except before and after contact information. A contact name is required to use SNMP Agent. Make sure to document the contact name, because settings will be cleared when SVP is replaced. <li data-bbox="570 447 1414 657">▪ Location: Location of connected subsystem. Storage Navigator users can change device locations with the modify mode. You must enter a device location using up to 180 alphanumeric characters (ASCII codes). You can use a space, except for before and after the location. You cannot use some symbols, such as ", \, ;, :, ,, *, ?, <, >, , /, ^, &, and %. The device location is required to use SNMP Agent. Make sure to document the device location, because the settings will be cleared when SVP is replaced.
Trap Test	<p data-bbox="570 678 1414 737">Executes test report of the trap to the community registered in the USP V or USP VM disk storage system.</p> <p data-bbox="570 747 1414 793">Operation in Modify mode is required to use this button. Operation authority is required as well.</p>
Apply	<p data-bbox="570 810 1414 835">Implements settings made on this window.</p>
Cancel	<p data-bbox="570 852 1414 877">Cancels settings made on this window.</p>

Performing SNMP Operations

This chapter describes adding and deleting an SNMP manager IP address, adding and deleting a community name, along with adding and deleting a community IP address:

- [Adding SNMP Manager IP Addresses](#)
- [Deleting SNMP Manager IP Addresses](#)
- [Adding a Community Name](#)
- [Deleting a Community Name](#)
- [Changing a Community Name](#)
- [Adding a Community IP Address](#)
- [Deleting a Community IP Address](#)
- [Testing the SNMP Trap report](#)

Adding SNMP Manager IP Addresses

To add SNMP Manager IP addresses:

1. Log on to open the **Storage Navigator Main** window. Change to **Modify** mode (refer to *Storage Navigator User's Guide* if you need instructions).
2. Click **Go – Environmental Settings – SNMP Information** in the menu bar of **Storage Navigator Main** window. The SNMP Information window appears (refer to Figure 2-1).
3. Select the radio box of Ipv4 or Ipv6 and specify the version of the IP address you enter.



Note: If the OS of SVP is Windows XP and you enter the Ipv6 address and select **Apply**, an error message is displayed and the Ipv6 address is not set.

4. Enter desired numerical IP address in **IP Address** text box (see Figure 3-1).
5. Select **Set**. The new IP address is added to **IP Address** list, but the changes are not implemented.
6. Select **Apply** to implement the changes, or select **Cancel** to cancel the changes, then select **OK** on the confirmation message.

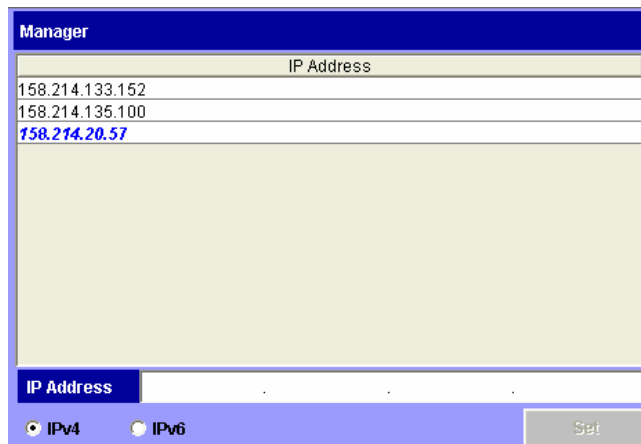

Figure 3-1 Adding SNMP Manager IP Address (Left: Before Setting, Right After Setting)

Deleting SNMP Manager IP Addresses

To delete an SNMP Manager IP address:

1. Change to **Modify** mode.
2. Log on to Storage Navigator. Click **Go – Environmental Settings – SNMP Information** in the menu bar of the **Storage Navigator Main** window. The SNMP Information window appears (see Figure 2-1).
3. Select one or more unwanted IP addresses from the **IP Address** list box. Right-click to display the **Delete IP Address** menu (see Figure 3-2).
4. Select **Delete IP Address**.
5. A confirmation message displays. Select **OK** or **Cancel**.
6. Select **Apply**. Select **OK** or **Cancel**.

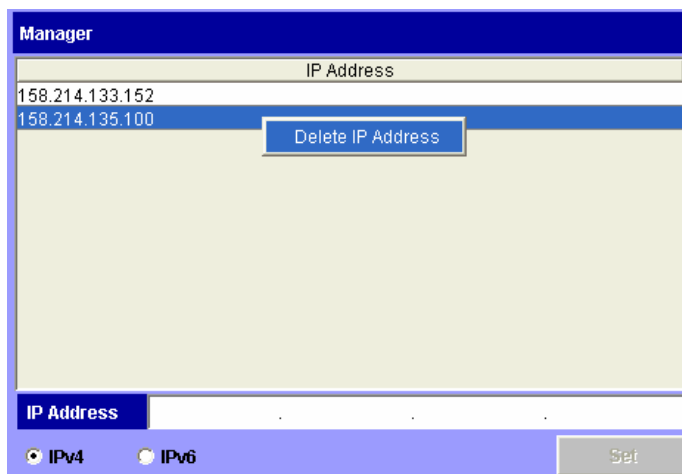

Figure 3-2 Delete IP Address Menu

Adding a Community Name

To add a community name:

1. Change to **Modify** mode.
2. Log on to Storage Navigator. Click **Go – Environmental Settings – SNMP Information** in the menu bar of the **Storage Navigator Main** window. The SNMP Information window appears (refer to Figure 2-1).
3. In **Community & Trap** box, select and right-click **Community**. The **Add Community** menu displays (see Figure 3-3).
4. Select **Add Community**. The **Community** dialog box (see Figure 3-4) displays.
5. In the **Community** text box, enter desired community name. You can use up to 180 alphanumeric characters, except for ", \, ;, :, , , * , ? , < , > , | , / , ^ , & , and % . You can also use spaces, except at the beginning or the end of the name.
6. Select **OK**. The new community name displays in **Community & Trap**, but the changes are not yet implemented in the subsystem.
7. If you want to add one or more IP addresses to the new community, see Adding Community IP Addresses.
8. To apply changes, select **Apply**. Select **OK** or **Cancel**.

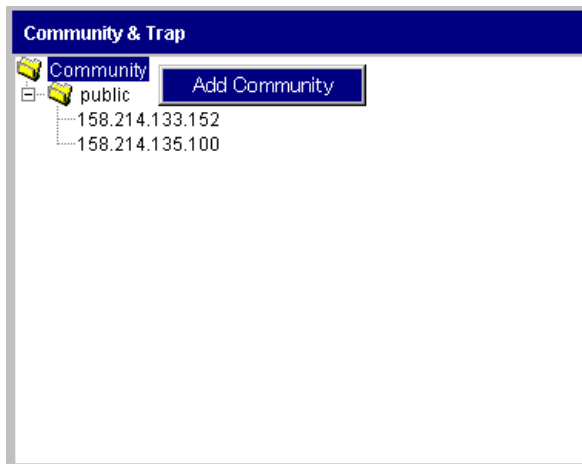

Figure 3-3 Add Community Menu

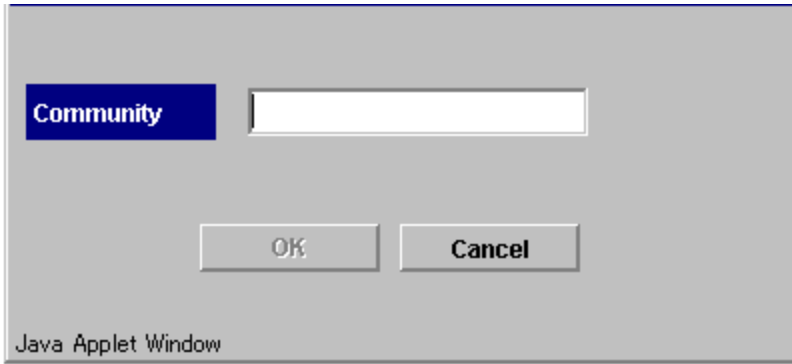

Figure 3-4 Add Community dialog box

Deleting a Community Name

To delete a community name:

1. Change to **Modify** mode.
2. Log on to open **Storage Navigator Main** window. Click **Go – Environmental Settings – SNMP Information** in the menu bar of **Storage Navigator Main** window. The SNMP Information window appears (see Figure 2-1).
3. In **Community & Trap**, select and then right-click the unwanted community. The **Delete Community** menu displays (see Figure 3-5).
4. Select the **Delete Community** command. A confirmation message displays.
5. Select **OK** or **Cancel**. The selected community is deleted from **Community & Trap**, but the setting is not yet implemented in the subsystem.
6. Select **Apply**. Select **OK** or **Cancel** on the confirmation message.

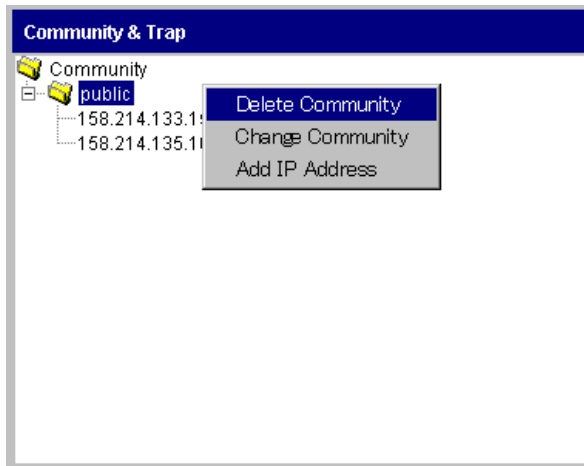

Figure 3-5 Delete Community Menu

Changing a Community Name

To change a community name:

1. Change to **Modify** mode (refer to *Storage Navigator User's Guide* if you need instructions).
2. Log on to Storage Navigator. Click **Go – Environmental Settings – SNMP Information** in the menu bar of **Storage Navigator Main** window. The SNMP Information window appears (see Figure 2-1).
3. Select and then right-click the community name that you want to change in **Community & Trap**. The **Change Community** menu displays (see Figure 3-6).
4. Select **Change Community**. The **Change Community** dialog box displays (see Figure 3-7).
5. In the **Community** text box, overwrite the old community name with a new community name. You can use up to 180 alphanumeric characters, except for ", \, ;, :, ,, *, ?, <, >, |, /, ^, &, and %. You can also use spaces, except at the beginning or the end of the name.
6. Select **OK**. The changed community name displays in **Community & Trap**, but the changes are not yet implemented in the subsystem.
7. Select **Apply**. Select **OK** or **Cancel**.



Figure 3-6 Change Community Menu

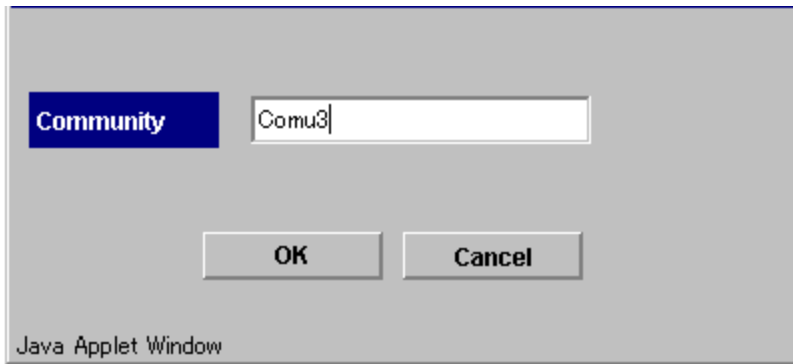

Figure 3-7 Change Community Dialog Box

Adding a Community IP Address

To add a community IP address:

1. Log on to Storage Navigator. Click **Go – Environmental Settings – SNMP Information** in the menu bar of **Storage Navigator Main** window. The SNMP Information window appears (see Figure 2-1).
2. Select and right-click the desired community to display the **Add Community** menu (see Figure 3-8).
3. Select **Add IP Address**. The **Add IP Address** dialog box displays (see Figure 3-9).
4. In **IP Address**, enter a new IP address or select an existing IP address.
 - If the values for an IP address are all set to zero (0), then that address cannot be specified for Ipv4 and Ipv6.
 - The Add IP Address dialog box does not support shortened expression of the Ipv6 address. Enter 8 hexadecimal numbers that are separated by colons (:) to a maximum 4 digits from zero (0) to FFFF inclusive.
 - When the OS of the SVP is Windows XP, if you enter an Ipv6 address and select Apply, an error message is displayed and the Ipv6 address cannot be set.
5. Select **OK**. The new IP address displays in **Community & Trap**, but the change is not yet implemented.
6. Select **Apply**. Select **OK** or **Cancel**.



Figure 3-8 Add IP Address Menu

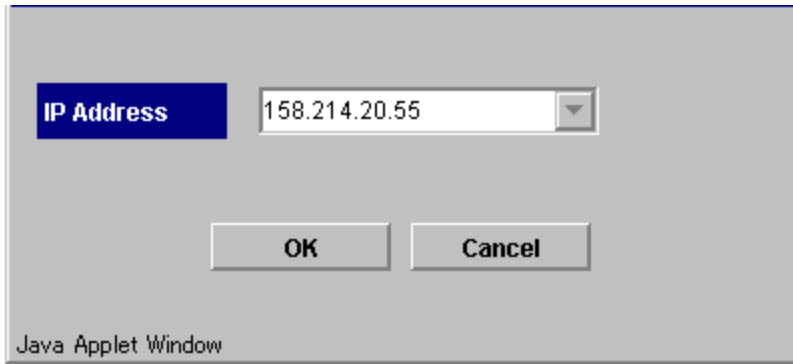

Figure 3-9 IP Address dialog box

Deleting a Community IP Address

To delete a community IP address:

1. Change to **Modify** mode.
2. Log on to Storage Navigator. Click **Go – Environmental Settings – SNMP Information** in the menu bar of **Storage Navigator Main** window. The SNMP Information window appears (see Figure 2-1).
3. In **Community & Trap**, select the unwanted community IP address. Right-click to display the **Delete IP Address** menu (see Figure 3-10).
4. Select **Delete IP Address**. A confirmation message displays.
5. Select **OK** or **Cancel**. The selected IP address is deleted from **Community & Trap**, but the change is not yet implemented.
6. Select **Apply** or **Cancel**. Select **OK** on the confirmation message.

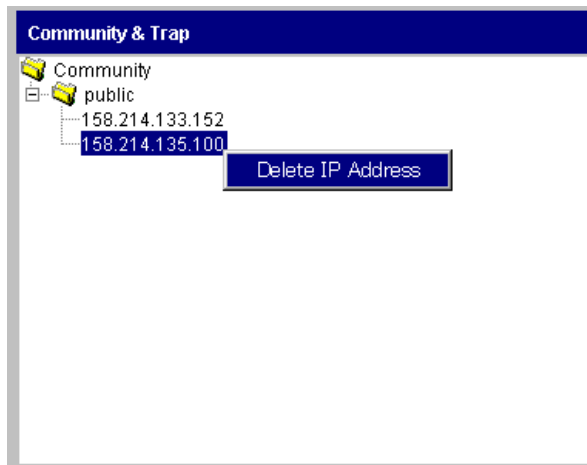

Figure 3-10 Delete Community IP Address

Testing the SNMP Trap Report

To test the SNMP Trap report:

1. Change to **Modify** mode.
2. Log on to Storage Navigator. Click **Go – Environmental Settings – SNMP Information** in the menu bar of **Storage Navigator Main** window. The SNMP Information window appears (refer to Figure 2-1).
3. Select **Trap Test**. A confirmation message displays.
4. Select **OK** or **Cancel**. Verify whether the SNMP trap report, which is reference code 7FFFFF, is received by the SNMP manager registered in the community.

SNMP Supported MIB

This chapter describes MIB specifications, standard and extension, the SNMP GUI, and trap configuration:

- [Trap Configuration](#)
- [Standard MIB Specifications](#)
- [Extension MIB Specifications](#)
- [Extension MIB Configuration](#)

Trap Configuration

Extension Trap Specifications

The specifications of the supported extension trap are listed in Table 4-1 and Table 4-2.

Table 4-1 Extension Trap Specifications

Operation	Specification	Mounting Value
SNMP Community	Specified community name	—
Protocol Data Unit (PDU) Type	Trap PDU	4
Enterprise ID	Agent Identifier	1.3.6.1.4.1.116.3.11.4.1.1
Agent IP Address	Agent IP Address	—
Generic Trap Code	Enterprise Specific	—
Specific Trap Code	See Table 4-2.	—

Table 4-2 Specific Trap Codes

Specific Trap Code	Name	Description
1	RaidEventUserAcute	Failure report: All operations in a subsystem stopped.
2	RaidEventUserSerious	Failure report: Operation in a component where a failure occurred stopped.
3	RaidEventUserModerate	Failure report: Partial failure.
4	RaidEventUserService	Failure report: Minor failure.

Extension Trap Protocol Data Unit

Failure Report Trap

An extension trap protocol data unit (PDU) includes the product number of the device that experienced the failure, the device nickname, and a failure reference code. If you obtain the information with GetRequest command, access the MIB by using the product number of the device as an index. Table 4-3 shows the failure report trap.

Table 4-3 Failure Report Trap

Name	Object Identifier	Type	Description
EventTrapSerialNumber	1.3.6.1.4.1.116.5.1 1.4.2.1	INTEGER	The product number of the device that experienced the failure.
EventTrapNickname	1.3.6.1.4.1.116.5.1 1.4.2.2	DisplayString	The device nickname.
EventTrapREFCODE	1.3.6.1.4.1.116.5.1 1.4.2.3	DisplayString	The failure reference
EventTrapPartsID	1.3.6.1.4.1.116.5.1 1.4.2.4	OBJECT IDENTIFIER	The area where the failure occurred (Note).
EventTrapDate	1.3.6.1.4.1.116.5.1 1.4.2.5	DisplayString	Failure occurrence date.
EventTrapTime	1.3.6.1.4.1.116.5.1 1.4.2.6	DisplayString	Failure occurrence time.
EventTrapDescription	1.3.6.1.4.1.116.5.1 1.4.2.7	DisplayString	Detailed information of a failure.
Note: For example, the object identifier for a failure in a storage system processor would be 1.3.6.1.4.1.116.5.11.4.1.1.6.1.2.			

Standard MIB Specifications

Supported MIB

Table 4-4 lists the supported MIBs. If you send a GET request for an object (MIB) that is not supported, you will receive **NoSuchName** as a GET RESPONSE.

Table 4-4 Supported MIBs

MIB		Supported?
Standard MIB: MIB-II	system group	Yes
	interface group	No
	at group	No
	ip group	No
	icmp group	No
	tcp group	No
	udp group	No
	egp group	No
	snmp group	No
Extension MIB		Yes

MIB Access Mode

The access mode for MIB in all communities is read only. If you send a GET request for a SET operation, you will receive **NoSuchName** as a GET RESPONSE.

Object Identifier System

An object system supported by SNMP agent is shown in Figure 4-1, Figure 4-2, and Figure 4-3.

Supported Traps

Table 4-5 lists and describes the supported trap types.

Table 4-5 Extension Trap Types

Specific Trap Code	Trap	Description
1	RaidEventUserAcute	All operations in a subsystem stopped.
2	RaidEventUserSerious	Operation in a component where a failure occurred stopped.
3	RaidEventUserModerate	Partial failure.
4	RaidEventUserService	Minor failure.

MIB Mounting Specifications

The supported MIB mounting specifications are as follows:

- mgmt OBJECT IDENTIFIER ::= {iso(1) org(3) dod(6) internet(1) 2 }
- mib-2 OBJECT IDENTIFIER ::= {mgmt 1}

An SNMP agent mounts only system groups in mib-2, as shown in Table 4-6.

Table 4-6 System Groups

Name	Description	Mounted Value
sysDescr {system 1}	Name of hardware or OS.	Fixed value RAID600
sysObjectID {system 2}	Object ID indicating the product identification number.	Fixed value. See Object Identifier System . 1.2.6.1.4.1.116.3.11.4.1.1
sysUpTime {system 3}	An accumulated time from an SNMP agent.	Unit: ms
sysContact {system 4}	A manager who manages an agent or a contact address.	Maximum 180 characters in an ASCII characters string (see Note) Input by a user from an SNMP setting window.
sysName {system 5}	A given name for managing an agent.	Maximum 180 characters in an ASCII characters string (see Note) Input by a user from an SNMP setting window.
sysLocation {system 6}	An agent setup location.	Maximum 180 characters in an ASCII characters string (see Note) Input by a user from an SNMP setting window.
sysService {system 7}	Value indicating a service.	Fixed value 76 (decimal)
Note: The following symbols cannot be used: \ , / : ; * ? " < > & % ^		

Extension MIB Specifications

Extension MIB Configuration

Figure 4-4 shows the Extension MIB configuration.

```
raidExMibRoot(1)
├ - raidExMibName(1)           SVP Product Name
├ - raidExMibVersion(2)       SVP Micro-program Version
├ - raidExMibAgentVersion(3)   Extension MIB Internal Version
├ - raidExMibDkcCount(4)      Number of DKC Under the Control of SVP
├ - raidExMibRaidList(5)      List of DKC Under the Control of SVP
├ - raidExMibDKCHW(6)         Disk Control Device Information
├ - raidExMibDKUHW(7)         Disk Device Information
├ - raidExMibTrapList(8)      Error Information List
├ - raidExMibDKCHW2(70)       Disk Control Device Information2
```

Figure 4-4 Extension MIB Configuration

raidExMibName

raidExMibName indicates the SVP product name.

	raidExMibName	OBJECT TYPE
SYNTAX	DisplayString	
ACCESS	read-only	
STATUS	mandatory	
DESCRIPTION	"SVP Product Name."	
OID	::={ raidExMibRoot 1}	

raidExMibVersion

raidExMibVersion indicates the micro-program version.

	RaidExMibVersion	OBJECT TYPE
SYNTAX	DisplayString	
ACCESS	read-only	
STATUS	mandatory	
DESCRIPTION	"SVP micro-program version."	
OID	::={ raidExMibRoot 2}	

raidExMibAgentVersion

raidExMibAgentVersion indicates the internal version of the extension MIB.

	raidExMibAgentVersion	OBJECT TYPE
SYNTAX		DisplayString
ACCESS		read-only
STATUS		mandatory
DESCRIPTION		"Extension Agent version."
OID		::={ raidExMibRoot 3}

Number of Storage Systems under Control of SVP (raidExMibDkcCount)

raidExMibDkcCount suggests the number of a storage system under the control of SVP.

	raidExMibDkcCount	OBJECT TYPE
SYNTAX		INTEGER
ACCESS		read-only
STATUS		mandatory
DESCRIPTION		"Registered subsystem number"
OID		::={ raidExMibRoot 4}

raidExMibRaidList

raidExMibRaidList indicates the subsystem under the control of the SVP.

	raidExMibRaidList	OBJECT TYPE
SYNTAX		SEQUENCE OF RaidListEntry
ACCESS		read-only
STATUS		mandatory
DESCRIPTION		"List of DKC."
OID		::={ raidExMibRoot 5}

(raidlistEntry)

raidlistEntry indicates the list of arrays managed by this SVP

	raidlistEntry	OBJECT TYPE
SYNTAX		RaidListEntry
ACCESS		not-accessible
STATUS		mandatory
DESCRIPTION		"Entry of DKC list."
INDEX		{ raidlistSerialNumber } ::={ raidExMibRaidList 1}

Table 4-7 lists the information displayed for each subsystem

Table 4-7 Subsystem Information

Name	Type	Description	Mounted Value	Attribute
raidlistSerialNumber ::=raidlistEntry(1)	INTEGER	Storage system product number (index).	1-99,999	read-only
raidlistMibNickName ::=raidlistEntry(2)	DisplayString	Storage system nickname.	(Max. 18 characters)	read-only
raidlistDKCMainVersion ::=raidlistEntry(3)	DisplayString	Micro-program version.	(Max. 10 characters)	read-only
raidlistDKCProductName ::=raidlistEntry(4)	DisplayString	Storage system product type.	* (7 characters)	read-only
* "RAID600" will be indicated as storage system product type (raidlistDKCProductName).				

raidExMibDKCHW

raidExMibDKCHW indicates the status of the subsystem components.

	raidExMibDKCHW	OBJECT TYPE
SYNTAX		SEQUENCE OF DKCHWEntry
ACCESS		read-only
STATUS		mandatory
DESCRIPTION		"Error information of the DKC."
OID		::={ raidExMibRoot 6}

dkCHWEntry

dkCHWEntry indicates the status of the subsystem components. Table 4-8 describes the status of the subsystem components.

	dkCHWEntry	OBJECT TYPE
SYNTAX		DKCHWEntry
ACCESS		not-accessible
STATUS		mandatory
DESCRIPTION		"Entry of DKC information."
INDEX		::={ raidExMibDKCHW 1}

Table 4-8 Subsystem Component Information

Name	Type	Description	MIB Value	Attribute
DKCRaidListIndexSerialNumber ::=dkcHWEntry(1)	INTEGER	Storage system product number (index).	1-99,999	read-only
DKCHWProcessor ::=dkcHWEntry(2)	INTEGER	Status of processor.	Note (1 digit)	read-only
DKCHWCSSW ::=dkcHWEntry(3)	INTEGER	Status of internal star.	Note (1 digit)	read-only
DKCHWCache ::=dkcHWEntry(4)	INTEGER	Status of cache.	Note (1 digit)	read-only
DKCHWMSM ::=dkcHWEntry(5)	INTEGER	Status of shared memory.	Note (1 digit)	read-only
DKCHWPS ::=dkcHWEntry(6)	INTEGER	Status of power supply.	Note (1 digit)	read-only
DKCHWBattery ::=dkcHWEntry(7)	INTEGER	Status of battery.	Note (1 digit)	read-only
DKCHWFan ::=dkcHWEntry(8)	INTEGER	Status of fan.	Note (1 digit)	read-only
DKCHWEnvironment ::=dkcHWEntry(9)	INTEGER	Others.	Note (1 digit)	read-only
<p>Note: The status of each component is indicated as follows:</p> <ul style="list-style-type: none"> 1: Normal. 2: Acute failure detected. 3: Serious failure detected. 4: Moderate failure detected. 5: Service failure detected. 				

raidExMibDKUHW

raidExMibDKUHW indicates the status of the subsystem components.

	raidExMibDKUHW	OBJECT TYPE
SYNTAX		SEQUENCE OF DKUHWEntry
ACCESS		read-only
STATUS		mandatory
DESCRIPTION		"Error information of the DKU."
OID		::={ raidExMibRoot 7}

dkuHWEntry

dkuHWEntry indicates the status of the disk unit components. Table 4-9 lists the disk device components information.

	dkuHWEntry	OBJECT TYPE
SYNTAX		DKUHWEntry
ACCESS		not-accessible
STATUS		mandatory
DESCRIPTION		"Entry of DKU information."
INDEX		{ DKURaidListIndexSerialNumber } ::={ raidExMibDKUHW 1}

Table 4-9 Disk Device Components Information

Name	Type	Description	MIB Value	Attribute
DKURaidListIndexSerialNumber ::=dkuHWEntry(1)	INTEGER	Storage system product number (index).	1-99,999	read-only
DKUHWPS ::=dkuHWEntry(2)	INTEGER	Status of power supply.	Note (1 digit)	read-only
DKUHWFan ::=dkuHWEntry(3)	INTEGER	Status of fan.	Note (1 digit)	read-only
DKUHWEEnvironment ::=dkuHWEntry(4)	INTEGER	Status of environment monitor.	Note (1 digit)	read-only
DKUHWDive ::=dkuHWEntry(5)	INTEGER	Status of drive.	Note (1 digit)	read-only

Note: The status of each component is indicated as follows:

- 1: Normal.
- 2: Acute failure detected.
- 3: Serious failure detected.
- 4: Moderate failure detected.
- 5: Service failure detected.

raidExMibDKCHW2

raidExMibDKCHW2 indicates the status of the subsystem components. Table 4-10 lists the subsystem components Information 2.

raidExMibDKCHW2	OBJECT TYPE
SYNTAX	SEQUENCE OF DKCHW2Entry
ACCESS	read-only
STATUS	mandatory
DESCRIPTION	"Error information of the DKC2."
OID	::={ raidExMibRoot 70}

dkcHW2Entry	OBJECT TYPE
SYNTAX	DKCHW2Entry
ACCESS	not-accessible
STATUS	mandatory
DESCRIPTION	"Entry of DKC2 information."
INDEX	{ DKC2RaidListIndexSerialNumber }
OID	::={ raidExMibDKCHW2 1}

Table 4-10 Subsystem Components Information 2

Name	Type	Description	MIB Value	Attribute
DKC2RaidListIndexSerialNumber ::=dkcHW2Entry(1)	INTEGER	Storage system product number (index).	1-99,999	read-only
DKCHW2Environment ::=dkcHW2Entry(2)	INTEGER	Information about environmental failure.	Note (1 digit)	read-only
DKCHW2SVP ::=dkcHW2Entry(3)	INTEGER	Status of SVP.	Note (1 digit)	read-only
DKCHW2PP ::=dkcHW2Entry(4)	INTEGER	Status of program product failure.	Note (1 digit)	read-only
<p>Note: The status of each component is indicated as follows:</p> <ul style="list-style-type: none"> 1: Normal. 2: Acute failure detected. 3: Serious failure detected. 4: Moderate failure detected. 5: Service failure detected. 				

raidExMibTrapList

raidExMibTrapList suggests the history of the failure traps. Table 4-11 describes the failure information.

raidExMibTrapList	OBJECT TYPE
SYNTAX	SEQUENCE OF EventTrapEntry
ACCESS	read-only
STATUS	mandatory
DESCRIPTION	"Trap list table."
	::={ raidExMibRoot 8 }
eventTrapEntry	OBJECT TYPE
SYNTAX	EventTrapEntry
ACCESS	non-accessible
STATUS	mandatory
DESCRIPTION	"Trap list table index."
INDEX	{ EventListIndexSerialNumber , EventListIndexRecordNo }
	::={ raidExMibTrapList 1 }

Table 4-11 Failure Information

Name	Type	Description	MIB Value	Attribute
EventListIndexSerialNumber ::=eventTrapEntry(1)	INTEGER	Storage system product number (index).	1-99,999	read-only
EventListNickname ::=eventTrapEntry(2)	DisplayString	Storage system nickname.	(Max. 18 characters)	read-only
EventListIndexRecordNo ::=eventTrapEntry(3)	Counter	Number of record.	1-256	read-only
EventListREFCODE ::=eventTrapEntry(4)	DisplayString	Reference code.	(6 characters)	read-only
EventListData ::=eventTrapEntry(5)	DisplayString	Date when the failure occurred.	yyyy/mm/dd (10 characters)	read-only
EventListTime ::=eventTrapEntry(6)	DisplayString	Time when the failure occurred.	hh:mm:ss (18 characters)	read-only
EventListDescription ::=eventTrapEntry(7)	DisplayString	Detailed information of the failure.	(maximum 256 characters)	read-only

Extension MIB Configuration

Figure 4-5 and Figure 4-6 show extension MIB configuration (1) and (2).

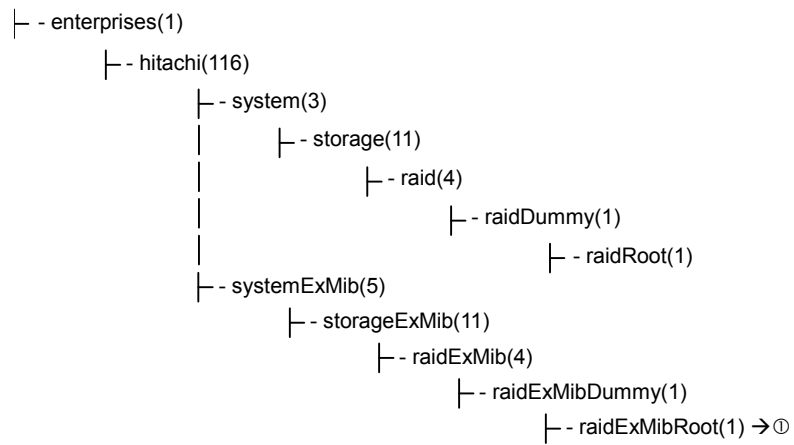

Figure 4-5 Extension MIB Configuration (1)

```

①→  |- raidExMibRoot(1)
      |- raidExMibName(1)
      |- raidExMibVersion(2)
      |- raidExMibAgentVersion(3)
      |- raidExMibDkcCount(4)
      |- raidExMibRaidList(5)
      |   |- raidlistEntry(1)
      |       |- raidlistSerialNumber(1)*
      |       |- raidlistMibNickName(2)
      |       |- raidlistDKCMainVersion(3)
      |       |- raidlistDKCProductName(4)
      |- raidExMibDKCHW(6)
      |   |- dkchWEntry(1)
      |       |- DKCRaidListIndexSerialNumber(1)*
      |       |- DKCHWProcessor(2)
      |       |- DKCHWCSW(3)
      |       |- DKCHWCache(4)
      |       |- DKCHWSM(5)
      |       |- DKCHWPS(6)
      |       |- DKCHWBattery(7)
      |       |- DKCHWFan(8)
      |       |- DKCHWEnvironment(9)
      |- raidExMibDKUHW(7)
      |   |- dkuHWEntry(1)
      |       |- DKURaidListIndexSerialNumber(1)*
      |       |- DKUHWPS(2)
      |       |- DKUHWFAN(3)
      |       |- DKUHWEnvironment(4)
      |       |- DKUHWDrive(5)
      |- raidExMibTrapList(8)
      |   |- eventTrapEntry(1)
      |       |- EventListIndexSerialNumber(1)*
      |       |- EventListNickName(2)
      |       |- EventListIndexRecorderNo(3)
      |       |- EventListREFCODE(4)
      |       |- EventListDate(5)
      |       |- EventListTime(6)
      |       |- EventListDescription(7)
      |- raidExMibDKCHW2(70)
      |   |- dkchW2Entry(1)
      |       |- DKC2RaidListIndexSerialNumber(1)*
      |       |- DKCHW2Environment(2)
      |       |- DKCHW2SVP(3)
      |       |- DKCHW2PP(4)

```

Figure 4-6 Extension MIB Configuration (2)

SNMP Failure Trap Reference

This chapter shows the alert level, trap reference code, description, and alert level:

- [SNMP Failure Trap Reference Codes](#)

SNMP Failure Trap Reference Codes

Table 5-1 lists and describes the SNMP failure trap reference codes. The SIM type for TrueCopy for z/OS® errors is determined by the mode. See Table 5-2.

Table 5-1 SNMP Failure Trap Reference Codes

Trap Reference Code			Description	Component	Alert Level
SIM22	SIM23	SIM13			
21	3x	yz	LCM hard error	Processor	MODERATE
21	72	xy	ADP blockade		MODERATE
21	80	xy	RIO path blockade		MODERATE
21	93	xy	Link data transfer error		SERIOUS
21	94	xy	Link data transfer error		SERIOUS
21	A0	xy	HTP hardware error		MODERATE
21	A2	xy	HTP path blockade		MODERATE
21	A3	xy	HTP blockade		MODERATE
21	D0	xy	External port blockade x: The CHA package number y: The number of the port in the package		MODERATE
21	D2	xy	External device response timeout x: The CHA package number y: The number of the port in the package		SERVICE
30	73	xy	Processor blockade		MODERATE
30	75	xy	FM failure		MODERATE
30	A0	xx	CHA PCB blockade xx=00:Fibre, xx=01:MFibre, xx=02:Serial xx=FF:All CHA		Acute
30	A1	00	DKC blockade		Acute
31	73	xy	Processor blockade		MODERATE
31	75	xy	FM failure	MODERATE	
31	A0	00	DKA PCB blockade	Acute	
CF	82	xy	DRR blockade	MODERATE	
CF	83	xy	FCA blockade	MODERATE	
FF	C2	xy	Cache Module Blockade processing finished	Cache	SERVICE
FF	C3	0x	Cache Package Blockade processing finished		SERVICE
FF	F1	xy	Cache temporary failure		SERVICE
FF	F2	xy	Module blockade		MODERATE
FF	F3	0x	Package blockade		MODERATE
FF	F4	0x	Module group blocking		SERIOUS
FF	E2	0x	Area blocking		SERIOUS

Trap Reference Code			Description	Component	Alert Level
SIM22	SIM23	SIM13			
FF	E9	01	Compatible PAV microprogram volatilization	Cache	SERIOUS
FF	EA	0x	Recovery of area blocked temporarily was completed		SERVICE
FF	EE	0x	Temporary blockade		SERVICE
DF	8y	xx	Drive port blockade (Path 0 side)	Drive	MODERATE
DF	9y	xx	Drive port blockade (Path 1 side)		MODERATE
DF	Ay	xx	LDEV blockade (Fibre blockade) (Path 0 side)		SERIOUS
DF	By	xx	LDEV blockade (Fibre blockade) (Path 1 side)		SERIOUS
EF	0x	xx	Drive blockade (Drive system) xxx: The drive number	Drive failure	SERIOUS
EF	1y	xx	Drive blockade (Drive system)	Drive	SERIOUS
EF	2y	xx	Drive blockade (Drive system)		SERVICE
EF	5x	yy	External volume write error		MODERATE
EF	9y	xx	LDEV blockade (Drive system)		SERIOUS
EF	D0	00	Device connecting to external subsystem is blocked		SERIOUS
FF	5x	yy	External volume read error		MODERATE
43	Bx	xx	Drive blockade (Media system) xxx: The drive number	Drive failure	SERIOUS
43	Cy	xx	Drive blockade (Media system)	Drive	SERIOUS
45	1y	xx	Correction copy start		SERVICE
45	2y	xx	Correction copy normal end		SERVICE
45	3y	xx	Correction copy abnormal end		SERIOUS
45	5y	xx	Correction copy warning end		SERVICE
46	1y	xx	Dynamic sparing start		SERVICE
46	2y	xx	Dynamic sparing normal end		SERVICE
46	3y	xx	Dynamic sparing abnormal end		MODERATE
46	5y	xx	Dynamic sparing warning end		SERVICE
49	0x	xx	Sidefile 40% over		SERVICE
AC	50	xy	HDU power supply shutdown detected	Power supply (DKU)	MODERATE
BF	1x	1x	Abnormal temperature	DKC environment	MODERATE
BF	2x	1x	Alarm for voltage	Power supply (DKC)	MODERATE
BF	4x	1x	Warning for power supply		MODERATE
BF	41	A5	Warning of power supply box	Power supply	MODERATE
BF	41	A6	Warning of power supply box		MODERATE
BF	5x	1x	Warning for battery	Battery	MODERATE
BF	58	xx	Warning for battery		MODERATE

Trap Reference Code			Description	Component	Alert Level
SIM22	SIM23	SIM13			
BF	60	D0	Warning for alternating current	DKC environment	MODERATE
BF	60	D1	(3 phase AC Box)		MODERATE
BF	6A	xx	Warning for alternating current (DKU AC Box)	Power supply (DKU)	MODERATE
BF	7x	1x	Abnormal fan	Fan (DKC)	MODERATE
BF	8x	Ax	Warning caused by remaining a jumper socket	DKC environment	MODERATE
BF	E3	A2	Error in two-SVP configuration	SVP error	MODERATE
BF	22	xx	AC-DC alarm	Power supply (DKU)	MODERATE
BF	48	xx	56V Low voltage	HDD-PL	MODERATE
BF	4C	xx	37V Low voltage		MODERATE
BF	78	xx	Abnormal fan		MODERATE
BF	79	xx	Fan fuse blow		MODERATE
74	Others		Sub-SVP error	SVP failure	MODERATE
7B	00	03	Router failure	Router failure	MODERATE
7C	03	00	Audit log FTP transfer failed	SVP failure	MODERATE
7F	F4	0x	Virus detected (Cleaning finished)		SERVICE
7F	F5	0x	Virus detected (Virus isolated)		MODERATE
7F	F6	0x	Virus detected (Virus isolation failed)		SERIOUS
7F	F7	xx	Expiration	License key	SERIOUS
7F	F8	xx	Exceeded the licensed capacity		SERIOUS
7F	F9	xx	Program product invalidated by the expiration of the prerequisite program product.		SERIOUS
7F	FF	FF	This is not a failure but a test code. This code is output only by the SNMP trap.	SVP	SERVICE
D4	0x	xx	Pair suspend due to RIO path blockade	Failure with paired volumes	SERIOUS
D4	1x	xx	Pair suspend due to failure detected in M-VOL		SERIOUS
D4	2x	xx	Pair suspend due to failure detected in R-VOL		SERIOUS
D4	3x	xx	Pair suspend due to DFW/DRV CAC off from R-VOL		SERIOUS
D4	4x	xx	Pair suspend due to the suspend report from R-VOL		SERIOUS
D4	5x	xx	Pair suspend due to the Simplex report from R-VOL		SERIOUS
D4	6x	xx	R-VOL has been suspended because an unrecoverable failure occurred in the remote copy connection.		SERIOUS
D4	8x	xx	Abnormal status occurring during ERASE operation in migration copy		SERIOUS
D4	Fx	xx	Suspicion of the pair status failure		SERIOUS

Trap Reference Code			Description	Component	Alert Level
SIM22	SIM23	SIM13			
DB	0x	yy	A currently used M-VOL has been suspended because an unrecoverable failure occurred in the remote copy connection. x: The CU number yy: The LDEV number	Failure with paired volumes	SERIOUS
DB	1x	yy	A currently used M-VOL has been suspended because an unrecoverable failure occurred in an M-VOL or the remote copy connection. x: The CU number yy: The LDEV number		SERIOUS
DB	2x	yy	A currently used M-VOL has been suspended because an unrecoverable failure occurred in an R-VOL. x: The CU number yy: The LDEV number		SERIOUS
DB	3x	yy	A currently used M-VOL has been suspended because DFW to R-VOL was prohibited. x: The CU number yy: The LDEV number		SERIOUS
DB	4x	yy	A currently used M-VOL has been suspended because an operation for suspending an R-VOL was performed. x: The CU number yy: The LDEV number		SERIOUS
DB	5x	yy	A currently used M-VOL has been suspended because an operation for deleting a pair was performed on an R-VOL. x: The CU number yy: The LDEV number		SERIOUS
DB	6x	yy	A currently used R-VOL has been suspended because an unrecoverable failure occurred in the remote copy connection. x: The CU number yy: The LDEV number		SERIOUS
DB	7x	yy	A currently used R-VOL has been suspended because an unrecoverable failure occurred in R-VOL. x: The CU number yy: The LDEV number		SERIOUS
DB	Dx	yy	MCU detected a moderate-level SIM of RCU. x: The CU number yy: The LDEV number		MODERATE
DB	Ex	yy	MCU detected an acute-level or serious-level SIM of RCU. x: The CU number yy: The LDEV number		SERIOUS

Trap Reference Code			Description	Component	Alert Level
SIM22	SIM23	SIM13			
DB	Fx	yy	The M-VOL status and the R-VOL status are not the same. x: The CU number yy: The LDEV number	Failure with paired volumes	SERIOUS
DC	0x	xx	Volume used as P-VOL has been suspended (Unable to restore path)		SERIOUS
DC	1x	xx	Volume used as P-VOL has been suspended (MCU failure detected)		SERIOUS
DC	2x	xx	Volume used as P-VOL has been suspended (RCU failure detected)		SERIOUS
DC	4x	xx	Volume used as P-VOL has been suspended (S-VOL suspension detected)		SERIOUS
DC	5x	xx	Volume used as P-VOL has been suspended (S-VOL pair deletion detected)		SERIOUS
DC	6x	xx	Volume used as S-VOL has been suspended (Unable to restore path)		SERIOUS
DC	7x	xx	Volume used as S-VOL has been suspended (RCU failure detected)		SERIOUS
DC	9x	yy	Volume used as a P-VOL of Delta resync has been suspended x: The CU number yy: The LDEV number		SERIOUS
DC	Ax	yy	Volume in the main storage system has been suspended because failure suspend occurs in the remote storage system.		SERIOUS
47	Dx	xx	Copying ended abnormally		MODERATE
47	E5	xx	Compatible FlashCopy V2 ended abnormally because of loss of data from the shared memory		MODERATE
47	E6	xx	Compatible FlashCopy ended abnormally because of loss of data from the shared memory		MODERATE
47	E7	00	Pair has been suspended forcibly because of loss of data from the shared memory.	MODERATE	
47	EC	00	The Copy-on-Write Snapshot option ended abnormally due to volatilization of the shared memory.	MODERATE	
47	Fx	xx	Volume migration ended abnormally	MODERATE	
4B	0x	xx	Background copying for canceling relationship ended abnormally	Copy failure	MODERATE
4B	2x	yy	Compatible FlashCopy V2 ended abnormally x: The CU number yy: The LDEV number	Failure with paired volumes	MODERATE
4B	3x	yy	The Copy-on-Write Snapshot option ended abnormally.		MODERATE
60	1x	xx	Exceeded the pool usage threshold.	Copy-on-Write Snapshot Pool	MODERATE

Trap Reference Code			Description	Component	Alert Level
SIM22	SIM23	SIM13			
60	2x	xx	Pool blockade	Copy-on-Write Snapshot Pool	MODERATE
60	2F	FF	No free area in SM.		MODERATE
62	0x	xx	Exceeded the pool usage threshold1.	Dynamic Provisioning Pool	MODERATE
62	1x	xx	Exceeded the pool usage threshold2.		MODERATE
62	2x	xx	Pool became full.		MODERATE
62	3x	xx	Pool detected a failure.		MODERATE
62	40	00	No free area in SM.		MODERATE
62	50	00	The pool usage threshold is being exceeded.		MODERATE
63	0x	xx	Exceeded the Dynamic Provisioning volume usage threshold.		MODERATE
The SIM Code for TrueCopy for z/OS® errors is determined by the mode. See Table 5-2.					
Others			Other failures	Other failures	SERIOUS

Table 5-2 SIM List for TrueCopy for z/OS® Errors

Mode	SIM22			
SYNC	D0	D1	D2	D4
SEMISYNC	D5	D6	D7	DB

Troubleshooting

This chapter provides troubleshooting information for the Hitachi SNMP Agent:

- [Mitigating SNMP Errors](#)
- [Calling the Hitachi Data Systems Support Center](#)

Mitigating SNMP Errors

Use **setup.exe** when you install a secondary SVP. If you do not, traps could be reported to an IP address that is not specified in SNMP settings. This could have serious consequences, including the following:

- **SNMP Security Function**

If the SNMP security function is working, and a command is executed from an IP address that is not entered, you will get a “no reply” return and a certification error is received for a trap.

- **SNMP Cold Trap Function**

- Depending on your network environment, when the SVP is rebooted you might not receive Microsoft® agent SNMP agent cold traps.
- The Microsoft® SNMP agent might report Link up/Link down Trap when the SVP reboots.
- A number of Link up/Link down Traps may be reported when the OS of the SVP is Windows Vista.

- **Abnormal Response to SNMP Command**

If an error occurs in the SVP, traps might not be sent.

- **Problems Inputting MIB Definition Files**

If you cannot input two or more MIB definition files because of the specifications of the SNMP manager software, use the MIB definition files for USP V/VM. Error reports include subsystem nicknames, which can be used to identify each subsystem (e.g., USP V/VM).

Calling the Hitachi Data Systems Support Center

If you need to call the Hitachi Data Systems Support Center, make sure to provide as much information about the problem as possible, including:

- The circumstances surrounding the error or failure.
- The content of any error message(s) displayed on the host system(s).
- The content of any error message(s) displayed on Storage Navigator.
- The Storage Navigator configuration information (use the FD Dump Tool).
- The service information messages (SIMs), including reference codes and severity levels, displayed by Storage Navigator.

The Hitachi Data Systems customer support staff is available 24 hours/day, seven days a week. If you need technical support, please call:

- United States: (800) 446-0744
- Outside the United States: (858) 547-4526



Acronyms and Abbreviations

CU	control unit (logical control unit)
DKA	disk adapter (another name for back-end director)
DKC	disk controller
GB	gigabytes (see Convention for Storage Capacity Values)
KB	kilobytes (see Convention for Storage Capacity Values)
LAN	local area network
LDEV	logical device
MB	megabytes (see Convention for Storage Capacity Values)
MCU	main control unit
MIB	message information block
M-VOL	main volume (TrueCopy for z/OS® primary volume)
MB	megabytes (see Convention for Storage Capacity Values)
PDU	protocol data unit
RCU	remote control unit
R-VOL	remote volume (TrueCopy for z/OS® secondary volume)
SGMP	Simple Gateway Management Protocol
SIM	service information message
SNMP	simple network management protocol
SVP	service processor
TB	terabytes (see Convention for Storage Capacity Values)
UDP	User Datagram Protocol
USP V	Hitachi Universal Storage Platform V
USP VM	Hitachi Universal Storage Platform VM
VOL	volume



Index

A

adding

- SNMP community IP address, 3-9
- SNMP community name, 3-4
- SNMP managers, 3-2

C

changing

- SNMP community name, 3-7

D

deleting

- SNMP community IP address, 3-11
- SNMP community name, 3-6
- SNMP managers, 3-3

I

instructions

- adding SNMP community IP address, 3-9
- adding SNMP community name, 3-4
- adding SNMP managers, 3-2
- changing SNMP community name, 3-7
- deleting SNMP community IP address, 3-11
- deleting SNMP community name, 3-6
- deleting SNMP managers, 3-3
- testing SNMP Trap Report, 3-12

S

SNMP Agent operations

- adding SNMP community IP address, 3-9
 - adding SNMP community name, 3-4
 - adding SNMP managers, 3-2
 - changing SNMP community name, 3-7
 - deleting SNMP community IP address, 3-11
 - deleting SNMP community name, 3-6
 - deleting SNMP managers, 3-3
 - testing SNMP Trap Report, 3-12
- SNMP Information tab, 2-2

T

Testing

- SNMP Trap Report, 3-12

Hitachi Data Systems

Corporate Headquarters

750 Central Expressway
Santa Clara, California 95050-2627
U.S.A.
Phone: 1 408 970 1000
www.hds.com
info@hds.com

Asia Pacific and Americas

750 Central Expressway
Santa Clara, California 95050-2627
U.S.A.
Phone: 1 408 970 1000
info@hds.com

Europe Headquarters

Sefton Park
Stoke Poges
Buckinghamshire SL2 4HD
United Kingdom
Phone: + 44 (0)1753 618000
info.eu@hds.com



MK-96RD620-13